

**User Manual for
Embedded PC**

EmbeddedLine EL1092-H (H110)

**6th /7th Gen. Intel® Core™
Fanless and
High Performance
Embedded PC**

**TL Electronic GmbH
Bgm.-Gradl-Str. 1
85232 Bergkirchen-Feldgeding
Germany**

Tel.: +49 (0)8131 33204-0
Fax: +49 (0)8131 33204-150
E-Mail: info@tl-electronic.de
www.tl-electronic.de

*Perfect
Industrial IT* 

EL1092 M1

EL1092 6th / 7th Gen.
Intel® Core™ Fanless and
High Performance Embedded PC

COPYRIGHT NOTICE & TRADEMARK

All trademarks and registered trademarks mentioned herein are the property of their respective owners.

This manual is copyrighted in Mar. 2017. You may not reproduce or transmit in any form or by any means, electronic, or mechanical, including photocopying and recording.

DISCLAIMER

This user's manual is meant to assist users in installing and setting up the system. The information contained in this document is subject to change without any notice.

CE NOTICE

This is a class A product. In a domestic environment this product may cause radio interference in which case the user may be required to take adequate measures.

FCC NOTICE

This equipment has been tested and found to comply with the limits for a Class A digital device, pursuant to part 15 of the FCC Rules. These limits are designed to provide reasonable protection against harmful interference when the equipment is operated in a commercial environment. This equipment generates, uses, and can radiate radio frequency energy and, if not installed and used in accordance with the instruction manual, may cause harmful interference to radio communications. Operation of this equipment in a residential area is likely to cause harmful interference in which case the user will be required to correct the interference at his own expense.

You are cautioned that any change or modifications to the equipment not expressly approve by the party responsible for compliance could void your authority to operate such equipment.

	<p>CAUTION: Danger of explosion may occur when the battery is incorrectly replaced. Replace the battery only with the same or equivalent type recommended by the manufacturer. Dispose of used batteries according to the manufacturer's instructions.</p>
---	---

	<p>WARNING: Some internal parts of the system may have high electrical voltage. We strongly recommend that only qualified engineers are allowed to service and disassemble the system. If any damages should occur on the system and are caused by unauthorized servicing, it will not be covered by the product warranty.</p>
---	---

Contents

Revision History	vii
1 Introduction	1-1
1.1 About This Manual	1-2
2 Getting Started	2-1
2.1 Package List.....	2-2
2.2 System Overview	2-3
2.2.1 Front View	2-3
2.2.2 Rear View (For EL1092 Rx-x0x)	2-4
2.2.3 Rear View (For EL1092 Rx-x1x)	2-4
2.2.4 Top View	2-5
2.2.5 Side View	2-5
2.2.6 Quarter View	2-6
2.3 System Specifications	2-7
2.4 Safety Precautions	2-9
3 System Configuration.....	3-1
3.1 CONNECTOR & JUMPER QUICK REFERENCE TABLE	3-2
3.2 Component Locations	3-4
3.2.1 Top View and Jumper Settings of EL1092	3-4
3.2.2 Bottom View of EL1092	3-6
3.3 How to Set Jumpers.....	3-7
3.4 Function Buttons and I/O Ports.....	3-9
3.4.1 Power Button	3-9
3.4.2 DC IN Port (For EL1092 Rx-x0x)	3-9

3.4.3	DC IN 3 Pins Terminal Block (For EL1092 Rx-x1x)	3-10
3.5	Setting Connectors and Jumpers.....	3-11
3.5.1	COM Port	3-11
3.5.2	COM1 Pin9 and COM2 PIN18 Definition Selection Guide.....	3-14
3.5.3	LAN1, LAN2 Ports.....	3-15
3.5.4	4 x 1 USB 3.0 Connectors	3-17
3.5.5	Dual USB 2.0 (H110) / USB 3.0 Connectors (Q170)	3-18
3.5.6	Digital Input/Output Connector (For EL1092 Rx-x1x) (optional).....	3-19
3.5.7	Digital Input/Output Connector (For EL1092 Rx-x0x) (optional).....	3-20
3.5.8	DVI-I Port	3-21
3.5.9	HDMI Port Connector	3-22
3.5.10	HD Audio Connector	3-23
3.5.11	Mini PCI Express Slots	3-24
3.5.12	Serial ATA (SATA) 3.0 Connectors	3-26
3.5.13	SATA Power Connectors.....	3-27
3.5.14	Power Input Connector	3-28
3.5.15	DC Power Input Connector	3-28
3.5.16	DC Out Port (Front Panel) (optional)	3-29
3.5.17	Power Output Connector	3-29
3.5.18	PCI Express Slot (x4)	3-30
3.5.19	I2C Wafer (optional).....	3-31
3.5.20	Parallel Port (LPT) Connector (optional)	3-31
3.5.21	Power Button Connectors	3-32
3.5.22	Rear Panel Power LED Connector	3-33
3.5.23	Rear Panel HDD LED Connector	3-33
3.5.24	CompactFlash Card Connector	3-34
3.5.25	SIM Card Slot.....	3-35
3.5.26	Hardware Power Failure Selection	3-35

3.5.27	CFast Voltage Control Selection	3-36
3.5.28	Low Pin Count (LPC) Connector	3-36
3.5.29	Flash Descriptor Override Selection	3-37
3.5.30	VCCIO Voltage Selection.....	3-37
3.5.31	BIOS Recovery Mode Selection	3-38
3.5.32	Clear CMOS Data Selection	3-38
4	Software Utilities	4-1
4.1	Introduction.....	4-2
4.2	Installing Intel® Chipset Software Installation Utility	4-5
4.2.1	Introduction	4-5
4.2.2	Intel® Chipset Software Installation Utility.....	4-5
4.3	Intel® Management Engine Components Installer Installation ..	4-6
4.4	Intel® USB 3.0 eXtensible Host Controller Utility	4-8
4.5	Installing RAID Driver Utility (Only for Q170, Optional)	4-9
4.6	Installing Graphics Driver Utility	4-11
4.7	Installing LAN Driver Utility.....	4-12
4.8	Installing Sound Driver Utility	4-13
5	BIOS SETUP	5-1
5.1	Introduction.....	5-2
5.2	Accessing Setup Utility.....	5-4
5.3	Main.....	5-7
5.4	Advanced	5-9
5.4.1	Advanced - CPU Configuration.....	5-10
5.4.2	Advanced - PCH-FW Configuration.....	5-12
5.4.3	Advanced – Trusted Computing	5-13

5.4.4	Advanced – ACPI Settings.....	5-14
5.4.5	Advanced – SATA Configuration.....	5-15
5.4.6	Advanced – Hardware Monitor	5-16
5.4.7	Advanced – F81866 Misc Configuration.....	5-17
5.4.8	Advanced – F81866 Super IO Configuration.....	5-18
5.4.12	Advanced - Network Stack Configuration	5-26
5.4.13	Advanced – USB Configuration	5-28
5.5	Chipset	5-29
5.5.1	Chipset – System Agent (SA) Configuration.....	5-30
5.5.1.1	Chipset – SA Configuration - Memory Configuration	5-32
5.5.1.2	Chipset – System Agent (SA) Configuration – Graphics Configuration.....	5-34
5.5.2	Chipset – PCH-IO Configuration.....	5-36
5.5.2.1	Chipset – PCH-IO Configuration – PCI Express Configuration.....	5-37
5.6	Security	5-41
5.7	Boot.....	5-43
5.7.1	Boot – Network Device BBS Priorities	5-45
5.7.2	Boot – Hard Drive BBS Priorities	5-46
5.7.3	Boot – CSM Configuration	5-47
5.8	Save & Exit.....	5-49

Appendix A System Diagrams	1
EL1092 System Exploded Diagram	2
Appendix B Technical Summary	1
Interrupt Map	2
I/O Map	19
Memory Map	20
Configuring WatchDog Timer	22
Flash BIOS Update	24

List of Figures

Figure 3-1. Main Board Component Location (Top View)	3-4
Figure 3-2. Main Board Component Location (Bottom View).....	3-6
Figure 5-1. Extensible Firmware Interface Diagram	5-2
Figure 5-2. POST Screen with AMI Logo.....	5-4

Revision History

The revision history of EL1092 User Manual is described below:

Version No.	Revision History	Date
M1	Initial Release	2017/06

1

Introduction

This chapter provides the introduction for the EL1092 system as well as the framework of the user manual.

The following topic is included:

- About This Manual

1.1 About This Manual

Thank you for purchasing our EL1092 system. The EL1092 is an updated system designed to be comparable with the highest performance of IBM AT personal computers. The EL1092 provides faster processing speed, greater expandability and can handle more tasks than before. This manual is designed to assist you how to install and set up the whole system. It contains 5 chapters and 2 appendixes. Users can configure the system according to their own needs. This user manual is intended for service personnel with strong hardware background. It is not intended for general users.

The following section outlines the structure of this user manual.

Chapter 1 Introduction

This chapter provides the introduction for EL1092 system as well as the framework of the user manual.

Chapter 2 Getting Started

This chapter describes the package contents and outlines the system specifications. It also includes the physical illustrations for the EL1092 system. Read the safety reminders carefully on how to take care of your system properly.

Chapter 3 System Configuration

This chapter outlines the locations of the motherboard components and their respective functions. You will learn how to set the jumpers and configure the system to meet your own needs.

Chapter 4 Software Utilities

This chapter contains helpful information for proper installations of the Intel Chipset Software Installation Utility, Intel Management Engine Components Installer Driver Utility, Intel USB 3.0 Extensible Host Controller Driver Utility, RAID Driver Utility (optional, only for Q170 SKU), Graphics Driver Utility, LAN Driver Utility and Sound Driver Utility.

Chapter 5 AMI BIOS Setup

This chapter indicates you how to change the BIOS configurations.

Appendix A System Assembly Diagrams

This appendix provides the exploded diagrams and part numbers of the EL1092.

Appendix B Technical Summary

This appendix provides the information about the system block diagram, allocation maps for system resources, Watchdog Timer Configuration and Flash BIOS Update.

2 Getting Started

This chapter provides the information for the EL1092 system. It describes how to set up the system quickly and outlines the system specifications.

The following topics are included:

- Package List
- System Overview
- System Specification
- Safety Precautions

Experienced users can go to Chapter 3 System Configuration on page 3-1 for a quick start.

2.1 Package List

If you discover any of the items listed below are damaged or lost, please contact your local distributor immediately.

Item	Part No.	Q'ty
(Main Unit)		
Manual		1
Driver DVD		1

2.2 System Overview

2.2.1 Front View

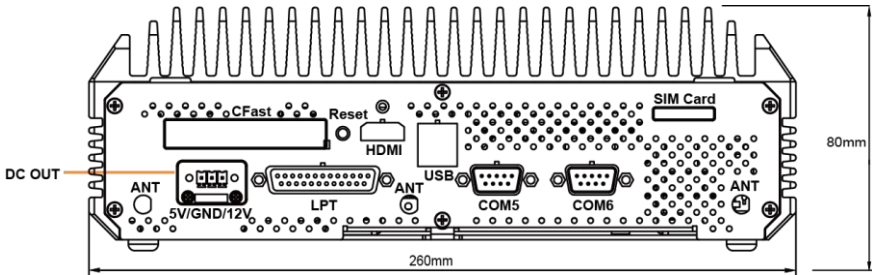

2.2.2 Rear View (Rx-x0x)

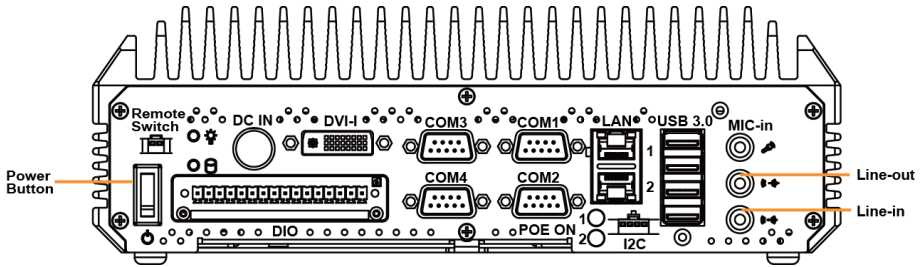

2.2.3 Rear View (Rx-x1x)

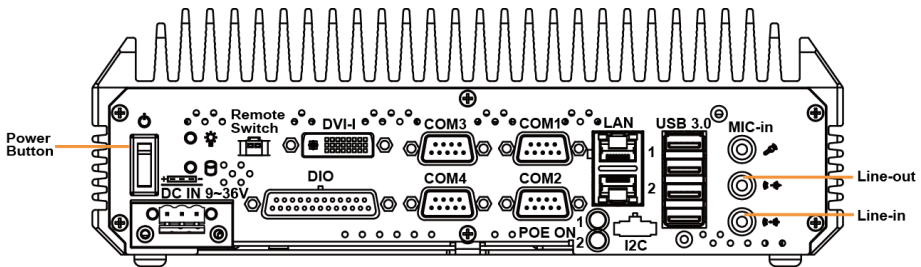

2.2.4 Top View

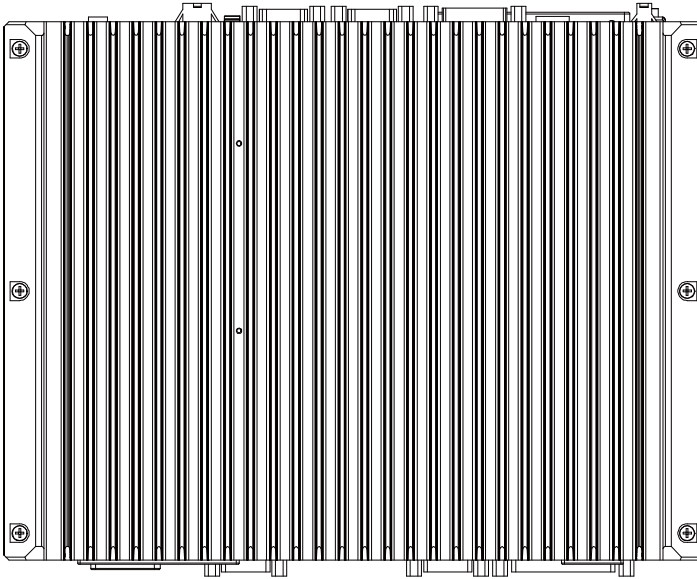

2.2.5 Side View

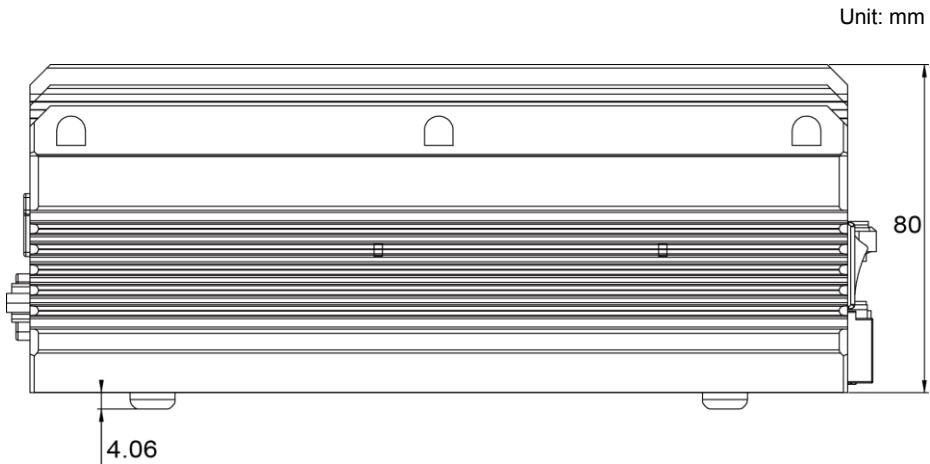

2.2.6 Quarter View

Unit: mm

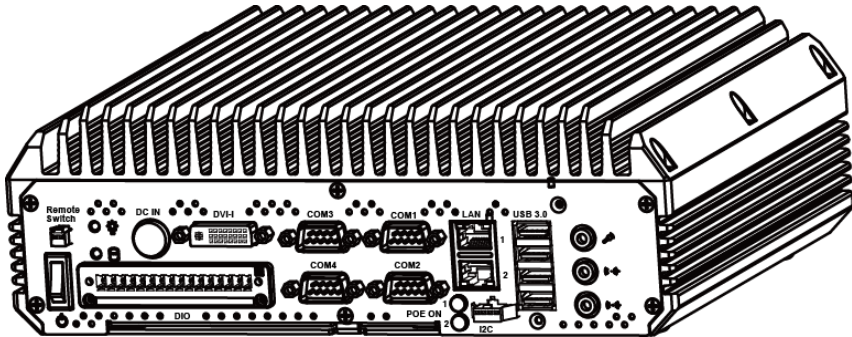

EL1092 (Rx-x0x)

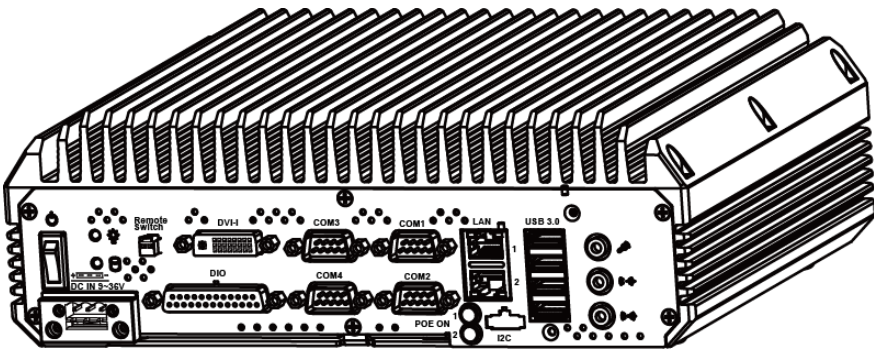

EL1092 (Rx-x1x)

2.3 System Specifications

System	
CPU Support	<ul style="list-style-type: none"> ➤ Intel Core™ i7-6700TE, Quad Core, 2.4GHz, 8M cache ➤ Intel Core™ i5-6500TE, Quad Core, 2.3GHz, 6M cache ➤ Intel Core™ i3-6100TE, Quad Core, 2.7GHz, 4M cache ➤ Intel Pentium® G4400TE, Dual Core, 2.4GHz, 3M cache ➤ Intel Celeron® G3900TE, Dual Core, 2.3GHz, 2M cache
Chipset	➤ Intel® Q170/ H110
Memory Support	➤ 2 x DDR4 2133MHz SO-DIMM up to 32 GB
Watchdog	➤ 1 ~ 255 seconds Watchdog timer selectable
Drive Bay	<ul style="list-style-type: none"> ➤ 2 x 2.5" SATAIII HDD/SSD (support RAID 0/1 in Q170 SKU only)
Audio	➤ 1 x Line-in / 1 x Line-out / 1 x MIC
Expansion Slot	<ul style="list-style-type: none"> ➤ 1 x Full-sized mini-PCle (mini PCIe, USB and SIM signals) ➤ 1 x Half-sized mini-PCle (mini PCIe and USB signals) ➤ 1 x SIM card slot ➤ 1 x CFast slot
System Weight	➤ 4.9 kg
Operating System	<ul style="list-style-type: none"> ➤ Windows 7 (64-bit) ➤ Windows 8.1 (64-bit) ➤ Windows 10 IoT LTSC 2016 ➤ Linux ubuntu 14.04 (64-bit)
Dimension (W x H x D)	➤ 260 x 80 x 200mm
Power Input	➤ DC in 9~36V
Certificate	➤ FCC / CE
I/O Ports (Front side)	
Display	➤ 1 x HDMI
USB	➤ 2 x USB 3.0 (Q170), 2 x USB 2.0 (H110)
Serial Port	➤ COM 5/6 for RS232 (optional)
Parallel Port	➤ 1 x LPT port (optional)
SIM Card	➤ 1 x SIM card slot
CFast Slot	➤ 1 x CFast card slot
Antenna	➤ 3 x antenna holes
I2C	➤ 1 x I2C port (optional)
Power Output	➤ 1 x 3-pin terminal block for DC-out 5V/12V (1A max)

I/O Ports (Rear side)	
Display	➤ 1 x DVI-I (DVI-D+VGA)
USB	➤ 4 x USB 3.0
Serial Port	<ul style="list-style-type: none"> ➤ COM3/4 for RS232 ➤ COM1/2 for RS232/422/485 (selectable by BIOS) ➤ [COM1/2 for +5V/+12V/RI selectable by jumper]
LAN	<ul style="list-style-type: none"> ➤ 2 x GbE LAN, Wake-On-LAN, PXE ➤ LAN 1: Intel® PHY 219 LM (10/100/1000 Mbps) ➤ LAN 2: Intel® LAN 210 AT (10/100/1000 Mbps)
Digital I/O Port	➤ 8 in / 8 out, DSUB-25 type or 16-pin terminal block (optional)
Audio	➤ 1 x Line-in / 1 x Line-out / 1 x MIC
Power Input	<ul style="list-style-type: none"> ➤ DC in 9~36V (DIN type 4-pin connector or 3-pin terminal block)
LED	➤ 1 x Power LED, 1 x HDD LED, 2 x PoE active LED (optional)
Power On/Off	➤ 1 x power button, 1 x remote switch
Environment	
Operating Temperature (with airflow)	<ul style="list-style-type: none"> ➤ HDD: 0°C ~ 40°C (32°F ~ 104°F) ➤ SSD: 0°C ~ 50°C (32°F ~ 112°F)
Storage Temperature	➤ -20°C ~ 80°C (-4°F ~ 176°F)
Humidity	➤ 20%~ 90%

2.4 Safety Precautions

Before operating this system, read the following information carefully to protect your systems from damages, and extend the life cycle of the system.

1. Check the Line Voltage
 - The operating voltage for the power supply should be within the range of 100V to 240V AC; otherwise the system may be damaged.
2. Environmental Conditions
 - Place your EL1092 on a sturdy, level surface. Be sure to allow enough space around the system to have easy access needs.
 - Avoid installing your EL1092 system in extremely hot or cold places.
 - Avoid direct sunlight exposure for a long period of time. (For example, in a closed car in summer time, avoid the system from any heating device also.) Or do not use EL1092 when it has been left outdoors in a cold winter day.
 - Avoid moving the system rapidly from a hot place to a cold place, and vice versa, because condensation may occur inside the system.
 - Protect your EL1092 from strong vibrations which may cause hard disk failure.
 - Do not place the system too close to any radio-active device. Radio-active device may cause signal interference.
 - Always shut down the operating system before turning off the power.
3. Handling
 - Avoid placing heavy objects on the top of the system.
 - Do not turn the system upside down. This may cause the hard drive to malfunction.
 - Do not allow any objects to fall into this device.
 - If water or other liquid spills into the device, unplug the power cord immediately.
4. Good Care
 - When the outside case gets stained, remove the stains using neutral washing agent with a dry cloth.
 - Never use strong agents such as benzene and thinner to clean the surface of the case.
 - If heavy stains are present, moisten a cloth with diluted neutral washing agent or alcohol and then wipe thoroughly with a dry cloth.
 - If dust is accumulated on the case surface, remove it by using a special vacuum cleaner for computers.

3

System Configuration

This chapter contains helpful information about the jumper & connector settings, and component locations for the main board.

The following topics are included:

- Connector & Jumper Quick Reference Table
- Main Board Component Locations
- How to Set Jumpers
- Setting Main Board Connectors and Jumpers

3.1 CONNECTOR & JUMPER QUICK REFERENCE TABLE

CONNECTOR Description	NAME
Clear CMOS Data Selection	CMOS1
LVDS Panel Resolution Selection	JP1, JP2
LVDS Voltage Selection	JP3
BIOS Recovery Mode Selection	JP4
Flash Descriptor Override Selection	JP7
CFast Voltage Control Selection	JP9
COM1 Pin9 RI/5V/12V Selection	JP12
COM2 Pin18 RI/5V/12V Selection	JP15
Hardware Power Failure Selection	JP16
VCCIO Voltage Selection	JP17

CONNECTOR Description	NAME
Rear I/O Port Connectors	
COM Port	COM1, COM2, COM3, COM4
LAN1, LAN2 Ports	LAN1, LAN2
4 x 1 USB 3.0 Connectors	USB1
(Optional) Digital Input/ Output Connector	DIO1
DVI-I Connector	DVI1
HD Audio Connector	AUDIO1
Power Button Connector	PWR_BTN1
Remote Switch Connector	PWR_BTN2
Rear Panel Power LED Connector	PWRLED1
Rear Panel HDD LED Connector	HDDLED1
Front I/O Port Connectors	
(Optional) COM5/COM6 Port	COM5, COM6
Dual USB 2.0 Connectors (H110)	USB2
Dual USB 3.0 Connectors (Q170)	USB2
HDMI Connector	HDMI1
CFast Card Slot	CFAST1
(Optional) Parallel Port (LPT) Connector	LPT1
(Optional) DC Out Port	DC Out

CONNECTOR Description	NAME
Mainboard Top Side Connectors	
(Optional) COM5/COM6 Pin Header	COM5, COM6
Full-Sized Mini PCI Express Slot	M_PCIE1
Half-Sized Mini PCI Express Slot	M_PCIE2
PCIe Slot x4	PCI_E1
Power Input Connector	PWR_IN1
DC Power Input Connector	ATX_PWR1
Power Output Connector	PWR_OUT1
SATA 3.0 Connectors	SATA1, SATA2
SATA Power Connectors	SATA_PWR1, SATA_PWR2
(Optional) I2C Wafer	I2C1
Low Pin Count (LPC) Connector	JLPC1
DDR4 SO-DIMM memory socket	SO-DIMM1
Mainboard Bottom Side Connectors	
SIM Card Slot (Front I/O)	SIM1
DDR4 SO-DIMM memory socket	SO-DIMM2

3.2 Component Locations

3.2.1 Top View and Jumper Settings

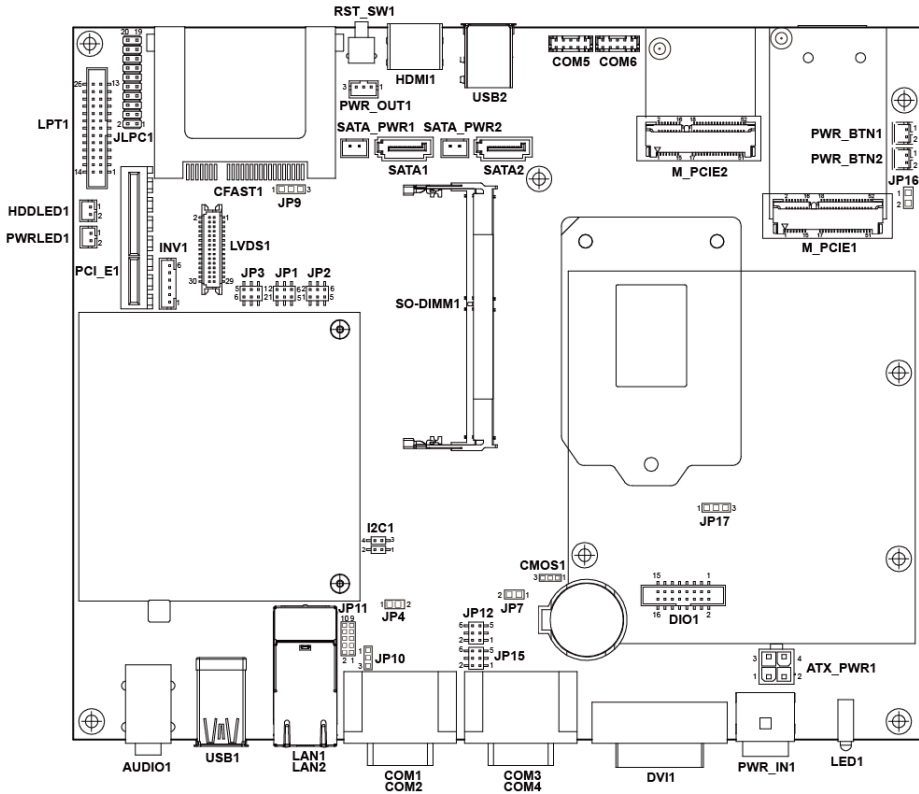





Figure 3-1. Main Board Component Location (Top View)

	<p>WARNING: Always disconnect the power cord when you are working with connectors and jumpers on the main board. Make sure both the system and peripheral devices are turned OFF as sudden surge of power could damage sensitive components. Make sure EL1092 is properly grounded.</p>
---	--

	<p>CAUTION: Observe precautions while handling electrostatic sensitive components. Make sure to ground yourself to prevent static charge while you are working on the connectors and jumpers. Use a grounding wrist strap and place all electronic components in any static-shielded devices.</p>
	<p>CAUTION: Always touch the motherboard components by the edges. Never touch components such as a processor by its pins. Take special cares while you are holding electronic circuit boards by the edges only. Do not touch the mainboard components.</p>

3.2.2 Bottom View

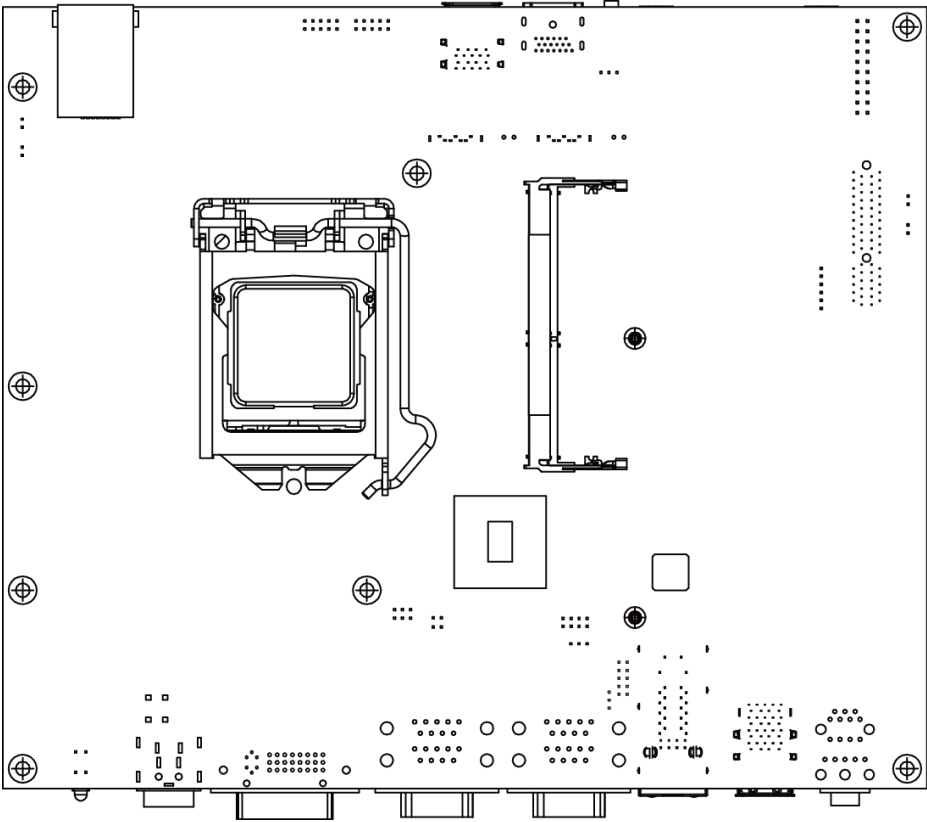

Figure 3-2. Main Board Component Location (Bottom View)

3.3 How to Set Jumpers

You can configure your board by setting the jumpers. A jumper consists of two or three metal pins with a plastic base mounted on the card. By using a small plastic "cap", also known as the jumper cap (with a metal contact inside), you are able to connect the pins. So you can configure your hardware settings by "opening" or "closing" jumpers.

Jumpers can be combined into sets that are called jumper blocks. When jumpers are all in the block, you have to put them together to set up the hardware configuration. The figure below shows what this looks like.

Jumpers & Caps

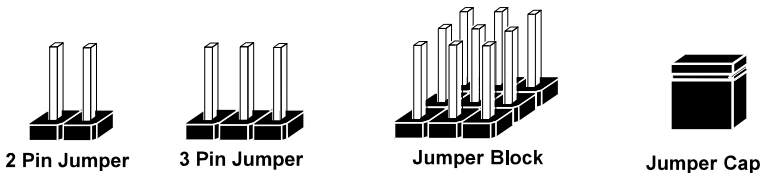

If a jumper has three pins, for example, labeled 1, 2 and 3. You can connect pins 1 and 2 to create one setting and shorting. You can also select to connect pins 2 and 3 to create another setting. The format of the jumper picture will be illustrated throughout this manual. The figure below shows different types of jumpers and jumper settings.

Jumper diagrams



Jumper Cap looks like this

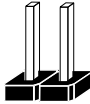

2 pin Jumper looks like this

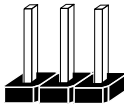

3 pin Jumper looks like this

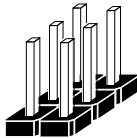

Jumper Block looks like this

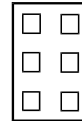

Jumper settings



2 pin Jumper closed(enabled)
looks like this



1

1



3 pin Jumper
2-3 pin closed(enabled)
looks like this



1

1



Jumper Block
1-2 pin closed(enabled)
looks like this

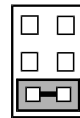

1 2

1 2

3.4 Function Buttons and I/O Ports

3.4.1 Power Button

Press the Power button located on the lower left side of rear panel.

ACTION	ASSIGNMENT
Press	0V
Release	PWRBTN

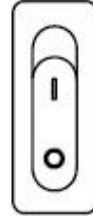

Power Button

3.4.2 DC IN Port (For Rx-x0x)

Port Name: DC IN

Description: DC Power-In Port

PIN	ASSIGNMENT	PIN	ASSIGNMENT
1	GND	2	GND
3	+12V	4	+12V

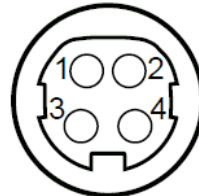

DC IN

Note: The 4-pin **DC IN** port (DIN) is not supported in **Rx-x1x**.

3.4.3 DC IN 3 Pins Terminal Block (For Rx-x1x)

Port Name: DC IN

Description: DC IN 3 pins terminal block

PIN	ASSIGNMENT
1	VCC: 9 ~ 36 VDC
2	-
3	GND

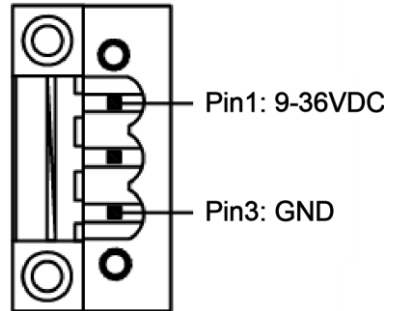

DC IN

Note: The 3-pin DC IN terminal block is not supported in Rx-x0x

3.5 Setting Connectors and Jumpers

3.5.1 COM Port

COM1(RS232/RS422/RS485) Connector Pin Assignment:

PIN	ASSIGNMENT		
	RS232 <i>(Default Setting)</i>	RS422	RS485
1	DCD#	TX-	RS-485-
2	RX	TX+	RS-485+
3	TX	RX+	X
4	DTR#	RX-	X
5	GND	GND	GND
6	DSR#	X	X
7	RTS#	X	X
8	CTS#	X	X
9	RI#	X	X

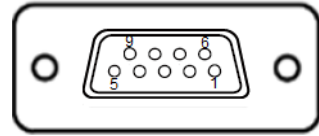

COM1

COM2(RS232/RS422/RS485) Connector Pin Assignment:

PIN	ASSIGNMENT		
	RS232 <i>(Default Setting)</i>	RS422	RS485
10	DCD#	TX-	RS-485-
11	RX	TX+	RS-485+
12	TX	RX+	X
13	DTR#	RX-	X
14	GND	GND	GND
15	DSR#	X	X
16	RTS#	X	X
17	CTS#	X	X
18	RI#	X	X

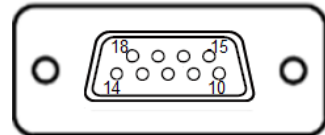

COM2

Notes:

1. COM1 Pin 9 and COM2 pin 18 are selectable for RI, +5V or +12V by jumper setting. Default setting is RI, please see “COM1 Pin9 and COM2 PIN18 Definition Selection Guide” for selection details
2. COM1,COM2 is selectable as RS232, RS422, RS485 by BIOS.
3. COM2 default setting is RS232. Please see **Chapter 5 “Advanced – F81866 Misc”** for selection details.

COM3(RS232) Connector Pin Assignment:

PIN	ASSIGNMENT	PIN	ASSIGNMENT
1	DCD#	6	DSR#
2	RX	7	RTS#
3	TX	8	CTS#
4	DTR#	9	RI#
5	GND	-	-

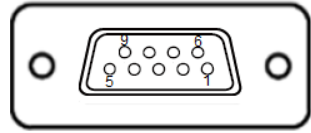

COM3

COM4(RS232) Connector Pin Assignment:

PIN	ASSIGNMENT	PIN	ASSIGNMENT
10	DCD#	15	DSR#
11	RX	16	RTS#
12	TX	17	CTS#
13	DTR#	18	RI#
14	GND	-	-

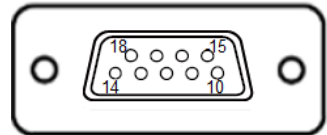

COM4

(Optional) COM5, COM6 (RS232) Connector (Front I/O) and COM5, COM6 Pin Header Pin Assignment:

PIN	ASSIGNMENT	PIN	ASSIGNMENT
1	DCD#	6	DSR#
2	RX	7	RTS#
3	TX	8	CTS#
4	DTR#	9	RI#
5	GND	-	-

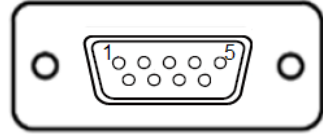

**COM5/
COM6 Port
(Front I/O)**

PIN	ASSIGNMENT	PIN	ASSIGNMENT
1	DCD#	6	DSR#
2	RX	7	RTS#
3	TX	8	CTS#
4	DTR#	9	RI#
5	GND	10	NC

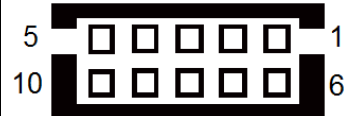

**COM5/
COM6 Pin Header
(M/B)**

3.5.2 COM1 Pin9 and COM2 PIN18 Definition Selection Guide

Jumper Location: JP12, JP15

Description: COM1 pin9 (JP12) and COM2 pin18 (JP15) RI/5V/12V Selection

SELECTION	JUMPER SETTING	JUMPER ILLUSTRATION	
RI	1-2 <i>(Default Setting)</i>	<p>JP12</p>	<p>JP15</p>
+12V	3-4	<p>JP12</p>	<p>JP15</p>
+5V	5-6	<p>JP12</p>	<p>JP15</p>

3.5.3 LAN1, LAN2 Ports

Port Name: LAN1

Description: LAN1, LAN2 Port, LAN RJ-45 Port (Rear I/O)

- LAN1: Intel® PHY 219 LM (10/100/1000Mbps)
- LAN2: Intel® LAN 210 AT (10/100/1000Mbps)

PIN	ASSIGNMENT
A1	MDI_1D0+
A2	MDI_1D0-
A3	MDI_1D1+
A4	MDI_1D1-
A5	MDI_1D2+
A6	MDI_1D2-
A7	MDI_1D3+
A8	MDI_1D3-
B1	MDI_2D0+
B2	MDI_2D0-
B3	MDI_2D1+
B4	MDI_2D1-
B5	MDI_2D2+
B6	MDI_2D2-
B7	MDI_2D3+
B8	MDI_2D3-

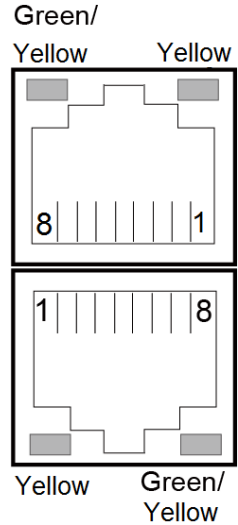

**LAN1/
LAN2**

LAN1 / LAN2 Status

There are LAN LED indicators on the rear side of the mainboard. By observing their status, you can know the status of the Ethernet connection.

LAN LED Indicator

Left Side LED

Green Color On	10/100Mbps LAN Speed Indicator
Yellow Color On	Giga LAN Speed Indicator
Off	No LAN Switch/HUB connected

Right Side LED

Yellow Color Blinking	LAN Message Active
Off	No LAN Message Active

3.5.4 4 x 1 USB 3.0 Connectors

Port Name: USB1

Description: USB 3.0 Ports x 4

USB 3.0 signals:

PIN	ASSIGNMENT	PIN	ASSIGNMENT
A1	+5V	A9	USB3_TX1+
A2	USB_D1-	A8	USB3_TX1-
A3	USB_D1+	A7	GND
A4	GND	A6	USB3_RX1+
-	-	A5	USB3_RX1-
B1	VCC5	B9	USB3_TX2+
B2	USB_D2-	B8	USB3_TX2-
B3	USB_D2+	B7	GND
B4	GND	B6	USB3_RX2+
-	-	B5	USB3_RX2-
C1	+5V	C9	USB3_TX3+
C2	USB_D3-	C8	USB3_TX3-
C3	USB_D3+	C7	GND
C4	GND	C6	USB3_RX3+
-	-	C5	USB3_RX3-
D1	VCC5	D9	USB3_TX4+
D2	USB_D4-	D8	USB3_TX4-
D3	USB_D4+	D7	GND
D4	GND	D6	USB3_RX4+
-	-	D5	USB3_RX4-

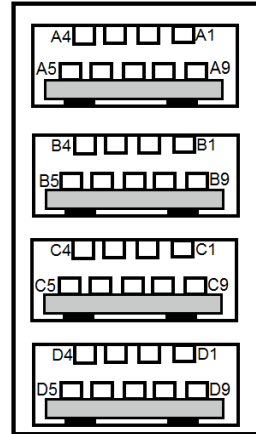

USB1

3.5.5 Dual USB 2.0 (H110) / USB 3.0 Connectors (Q170)

Port Name: USB2

Description: Dual USB 2.0 port connectors (H110) or Dual USB 3.0 port connectors (Q170). The dual USB 2.0 connectors (H110) or dual USB 3.0 connectors (Q170) share the same pin assignments as below:

USB 2.0 / USB 3.0 signals:

PIN	ASSIGNMENT	PIN	ASSIGNMENT
A1	+5V	A9	USB3_TX_P
A2	USB2_N	A8	USB3_TX_N
A3	USB2_P	A7	GND
A4	GND	A6	USB3_RX_P
-	-	A5	USB3_RX_N
B1	+5V	B9	USB3_TX_P
B2	USB2_N	B8	USB3_TX_N
B3	USB2_P	B7	GND
B4	GND	B6	USB3_RX_P
-	-	B5	USB3_RX_N

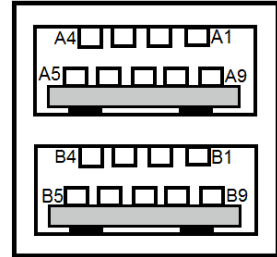

USB2

3.5.6 Digital Input/Output Connector (For Rx-x1x) (optional)

Connector Location: DIO1

Description: M/B DIO Port Connector 16 pins

PIN	ASSIGNMENT	PIN	ASSIGNMENT
1	DIN1	2	DOUT1
3	DIN2	4	DOUT2
5	DIN3	6	DOUT3
7	DIN4	8	DOUT4
9	DIN5	10	DOUT5-
11	DIN6	12	DOUT6
13	DIN7	14	DOUT7
15	DIN8	16	DOUT8



DIO1

System Digital I/O Port DSUB-25 pins (rear I/O)

PIN	ASSIGNMENT	PIN	ASSIGNMENT
1	DIN1	14	DOUT1
2	DIN2	15	DOUT2
3	DIN3	16	DOUT3
4	DIN4	17	DOUT4
5	DIN5	18	DOUT5
6	DIN6	19	DOUT6
7	DIN7	20	DOUT7
8	DIN8	21	DOUT8
9	-	22	-
10	-	23	-
11	-	24	-
12	-	25	-
13	-	-	-

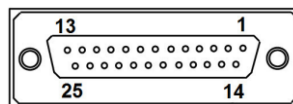

DIO Port

Note: The 25-pin D-Sub DIO connector is not supported in **Rx-x0x**.

**3.5.7 Digital Input/Output Connector (For Rx-x0x)
(optional)**

Connector Location: DIO1

Description: M/B DIO Port Connector 16 pins

PIN	ASSIGNMENT	PIN	ASSIGNMENT
1	DIN1	2	DOUT1
3	DIN2	4	DOUT2
5	DIN3	6	DOUT3
7	DIN4	8	DOUT4
9	DIN5	10	DOUT5-
11	DIN6	12	DOUT6
13	DIN7	14	DOUT7
15	DIN8	16	DOUT8



DIO1

System 16 pins terminal block DIO Port

PIN	ASSIGNMENT
1	DIN1
2	DIN2
3	DIN3
4	DIN4
5	DIN5
6	DIN6
7	DIN7
8	DIN8
9	DOUT1
10	DOUT2
11	DOUT3
12	DOUT4
13	DOUT5-
14	DOUT6
15	DOUT7
16	DOUT8

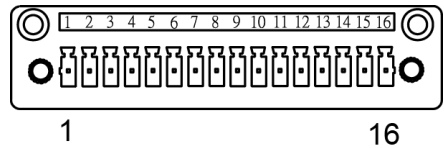

DIO Port

Note: The 16-pin terminal block DIO port is not supported in **Rx-x1x**.

3.5.8 DVI-I Port

Connector Location: DVI1

Description: DVI (Digital Visual Interface) Integrated Connector

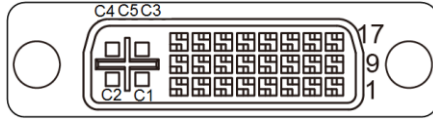

DVI1

PIN	ASSIGNMENT	PIN	ASSIGNMENT
1	TMDS_D2-	13	NC
2	TMDS_D2+	14	+5V
3	GND	15	GND
4	NC	16	TMDS_HPDP
5	NC	17	TMDS_D0-
6	TMDS_CLK	18	TMDS_D0+
7	TMDS_DATA	19	GND
8	VSYNC	20	NC
9	TMDS_D1-	21	NC
10	TMDS_D1+	22	GND
11	GND	23	TMDS_D3+
12	NC	24	TMDS_D3-
C1	RED	C2	GREEN
C3	BLUE	C4	HSYNC
C5	GND	C6	-

3.5.9 HDMI Port Connector

Connector Location: HDMI1

Description: Display Port Connector

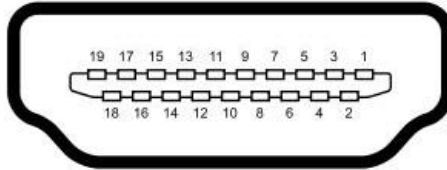

HDMI1

PIN	ASSIGNMENT	PIN	ASSIGNMENT
1	HDMI_D2+	2	GND
3	HDMI_D2-	4	HDMI_D1+
5	GND	6	HDMI_D1-
7	HDMI_D0+-	8	GND
9	HDMI_D0-	10	HDMI_D3+
11	GND	12	HDMI_D3-
13	CEC	14	RSVD
15	HDMI_CLK	16	HDMI_DATA
17	GND	18	+5V
19	HDMI_HPD	20	-

3.5.10 HD Audio Connector

Connector Location: AUDIO1

Description: HD Audio Connector for Line_in/Line_out/Mic_in.

PIN	ASSIGNMENT
2	MIC_IN_L
3	GND
1	GND
4	GND
5	MIC_IN_R
22	LINE_OUT_L
23	GND
24	GND
25	LINE_OUT_R
32	LINE_IN_L
33	GND
34	GND
35	LINE_IN_R
42	NC
43	NC
44	NC

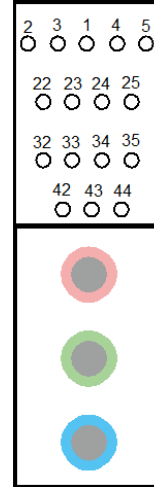

AUDIO1

3.5.11 Mini PCI Express Slots

Connector Location: M_PCIE1 and M_PCIE2

Description: Mini-PCI Express Slots

Full-Sized Mini-PCI Express Slot 1 (M_PCIE1) signals:

PIN	ASSIGNMENT	PIN	ASSIGNMENT
1	WAKE#	2	+3.3V_SB
3	NC	4	GND
5	NC	6	+1.5V
7	CLKREQ#	8	SIM_PWR
9	GND	10	SIM_DAT
11	REFCLK+	12	SIM_CLK
13	REFCLK-	14	SIM_RST
15	GND	16	SIM_VPP
17	SIM_SW1	18	GND
19	SIM_SW2	20	NC
21	GND	22	PERST#
23	PE_RX7+	24	+3.3V_SB
25	PE_RX7-	26	GND
27	GND	28	+1.5V
29	GND	30	SMB_CLK
31	PE_TX7-	32	SMB_DATA
33	PE_TX7+	34	GND
35	GND	36	USB_D9-
37	GND	38	USB_D9+
39	+3.3V_SB	40	GND
41	+3.3V_SB	42	NC
43	GND	44	NC
45	NC	46	NC
47	NC	48	+1.5V
49	NC	50	GND
51	NC	52	+3.3V_SB

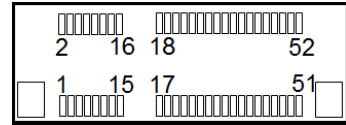

**M_PCIE1/
M_PCIE2**

Half-Sized Mini-PCI Express Slot 2 (M_PCIE2) signals:

PIN	ASSIGNMENT	PIN	ASSIGNMENT
1	WAKE#	2	+3.3V_SB
3	NC	4	GND
5	NC	6	+1.5V
7	CLKREQ#	8	NC
9	GND	10	NC
11	REFCLK+	12	NC
13	REFCLK-	14	NC
15	GND	16	NC
17	NC	18	GND
19	NC	20	NC
21	GND	22	PERST#
23	PE_RX8-	24	+3.3V_SB
25	PE_RX8+	26	GND
27	GND	28	+1.5V
29	GND	30	SMB_CLK
31	PE_TX8-	32	SMB_DATA
33	PE_TX8+	34	GND
35	GND	36	USB_D10-
37	GND	38	USB_D10+
39	+3.3V_SB	40	GND
41	+3.3V_SB	42	NC
43	GND	44	NC
45	NC	46	NC
47	NC	48	+1.5V
49	NC	50	GND
51	NC	52	+3.3V_SB

Mini PCI Express is the successor of the Mini PCI card and provides an increased data throughput. The cards have a detached network interface and are equipped with one lane. They are used in particular in embedded designs or compact box PCs.

3.5.12 Serial ATA (SATA) 3.0 Connectors

Connector Location: SATA1 and SATA2

Description: Serial ATA 3.0 Connectors

Serial ATA 3.0 Connector 1 (SATA1) signals:

PIN	ASSIGNMENT
1	GND
2	SATA TX+
3	SATA TX-
4	GND
5	SATA RX-
6	SATA RX+
7	GND

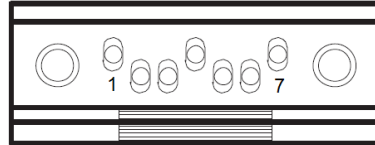

**SATA1/
SATA2**

Serial ATA 3.0 Connector 2 (SATA2) signals:

PIN	ASSIGNMENT
1	GND
2	SATA TX1+
3	SATA TX1-
4	GND
5	SATA RX1-
6	SATA RX1+
7	GND

3.5.13 SATA Power Connectors

Connector Location: SATA_PWR1 and SATA_PWR2

Description: Serial ATA Power Connectors

Serial ATA Power Connector 1 (SATA_PWR1) signals:

PIN	ASSIGNMENT
1	+5V
2	GND

Serial ATA Power Connector 2 (SATA_PWR2) signals:

PIN	ASSIGNMENT
1	+5V
2	GND

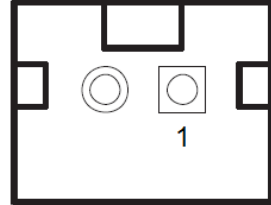

**SATA_PWR1/
SATA_PWR2**

3.5.14 Power Input Connector

Connector Location: PWR_IN1

Description: Power Input Connector

PIN	ASSIGNMENT	PIN	ASSIGNMENT
1	GND	2	GND
3	+12V	4	+12V

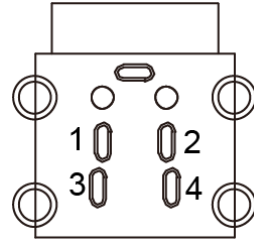

PWR_IN1

3.5.15 DC Power Input Connector

Connector Location: ATX_PWR1

Description: DC Power Input Connector

PIN	ASSIGNMENT	PIN	ASSIGNMENT
1	GND	3	+12V
2	GND	4	+12V

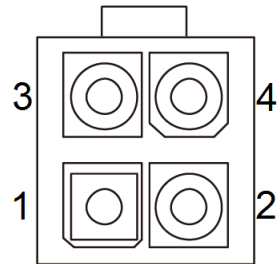

ATX_PWR1

3.5.16 DC Out Port (Front Panel) (optional)

Port Location: DC Out

Description: 3-pin terminal block for DC-out 5V/12V (1A max)

PIN	ASSIGNMENT
1	VCC5
2	GND
3	VCC12

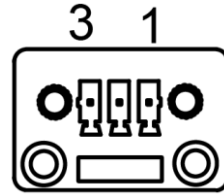

DC Out

3.5.17 Power Output Connector

Connector Location: PWR_OUT1

Description: Power Output Connector

PIN	ASSIGNMENT
1	+5V
2	GND
3	+12V

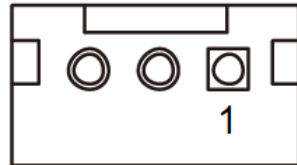

PWR_OUT1

3.5.18 PCI Express Slot (x4)

Connector Location: PCI_E1

Description: PCI Express Slot x4 (Not supported in H110 chip)

PCI_E1 is only supported in Q170 SKU.

PIN	ASSIGNMENT	PIN	ASSIGNMENT
B1	+12V	A1	PRSNT#1
B2	+12V	A2	+12V
B3	+12V	A3	+12V
B4	GND	A4	GND
B5	SMB_CLK	A5	NC
B6	SMB_DATA	A6	NC
B7	GND	A7	NC
B8	+3.3V	A8	NC
B9	NC	A9	+3.3V
B10	+3.3V_AXU	A10	+3.3V
B11	WAKE#	A11	PERST#
B12	RSVD	A12	GND
B13	GND	A13	REFCLK+
B14	HSOP0	A14	REFCLK-
B15	HSO0	A15	GND
B16	GND	A16	HSIP0
B17	PRSNT#2	A17	HSIN0
B18	GND	A18	GND
B19	HSOP1	A19	RSVD
B20	HSO1	A20	GND
B21	GND	A21	HSIP1
B22	GND	A22	HSIN1
B23	HSOP2	A23	GND
B24	HSO2	A24	GND
B25	GND	A25	HSIP2
B26	GND	A26	HSIN2
B27	HSOP3	A27	GND
B28	HSO3	A28	GND
B29	GND	A29	HSIP3
B30	RSVD	A30	HSIN3
B31	PRSNT#2	A31	GND
B32	GND	A32	RSVD

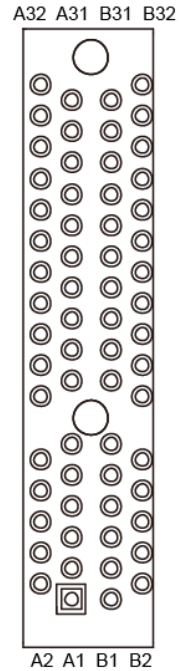

PCI_E1(x4)

3.5.19 I2C Wafer (optional)

Connector Location: I2C1

Description: I2C Wafer

PIN	ASSIGNMENT	PIN	ASSIGNMENT
1	I2C SDA	2	I2C SCL
3	I2C SDA	4	I2C SCL

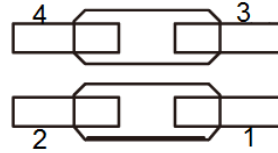

I2C1

3.5.20 Parallel Port (LPT) Connector (optional)

Connector Location: LPT1

Description: Parallel Port Connector

PIN	ASSIGNMENT	PIN	ASSIGNMENT
1	STB#	14	ALF#
2	PDR0	15	ERR#
3	PDR1	16	PAR_INIT#
4	PDR2	17	SLCTIN#
5	PDR3	18	GND
6	PDR4	19	GND
7	PDR5	20	GND
8	PDR6	21	GND
9	PDR7	22	GND
10	ACK#	23	GND
11	BUSY	24	GND
12	PE	25	GND
13	SLCT#	26	NC

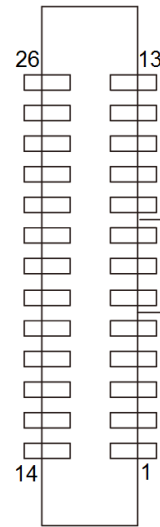

LPT1

3.5.21 Power Button Connectors

Connector Location: PWR_BTN1, PWR_BTN2

Description: Power Button and Remote Switch Connectors

PWR_BTN1 : Power Button Connector

PIN	ASSIGNMENT
1	PWR_BTN
2	GND

PWR_BTN2 : Remote Switch Connector

PIN	ASSIGNMENT
1	PWR_BTN
2	GND

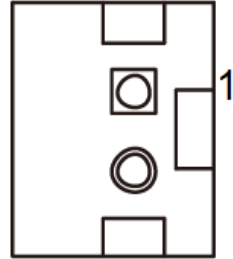

**PWR_BTN1/
PWR_BTN2**

3.5.22 Rear Panel Power LED Connector

Connector Location: PWRLED1

Description: Power LED Connector

PIN	ASSIGNMENT
1	PWRLED+
2	GND

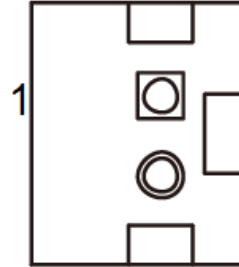

PWRLED1

3.5.23 Rear Panel HDD LED Connector

Connector Location: HDDLED1

Description: Hard Disk Drive LED Connector

PIN	ASSIGNMENT
1	HDDLED+
2	HDDLED-

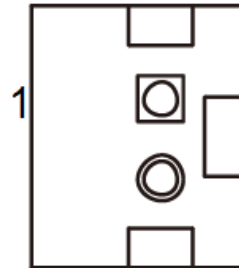

HDDLED1

3.5.24 CompactFlash Card Connector

Connector Location: CFAST1

Description: CompactFlash Card Connector

PIN	ASSIGNMENT
S1	GND
S2	SATA_TXP0
S3	SATA_TXN0
S4	GND
S5	SATA_RXN0
S6	SATA_RXP0
S7	GND
PC1	NC
PC2	GND
PC3	NC
PC4	NC
PC5	NC
PC6	NC
PC7	GND
PC8	NC
PC9	NC
PC10	NC
PC11	NC
PC12	NC
PC13	PWR
PC14	PWR
PC15	GND
PC16	GND
PC17	NC

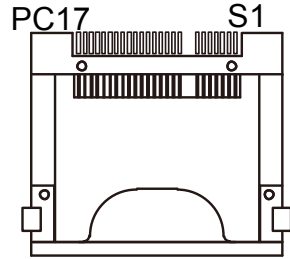

CFAST1

3.5.25 SIM Card Slot

Connector Location: SIM1 (rear side of mainboard)

Description: SIM (Subscriber Identity Module) Card Connector

PIN	ASSIGNMENT	PIN	ASSIGNMENT
C5	GND	C1	VSIM
C6	VPP	C2	RST
C7	DATA	C3	CLK
C8	RSV	C4	RSV

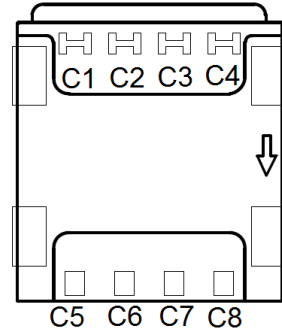

SIM1

3.5.26 Hardware Power Failure Selection

Jumper Location: JP16



Description: Hardware Power Failure Selection

SELECTION	JUMPER SETTING	JUMPER ILLUSTRATION
Enable	Close	<p>JP16</p>
Disable	<i>Open (Default Setting)</i>	<p>JP16</p>

3.5.27 CFast Voltage Control Selection

Jumper Location: JP9

Description: CompactFlash (CFast) Voltage Control Selection

SELECTION	JUMPER SETTING	JUMPER ILLUSTRATION
+3.3V	1-2 <i>(Default Setting)</i>	 <p>JP9</p>
+5V	2-3	 <p>JP9</p>

3.5.28 Low Pin Count (LPC) Connector

Connector Location: JLPC1

Description: Low Pin Count (LPC) Connector

PIN	ASSIGNMENT	PIN	ASSIGNMENT
1	CLK	2	GND
3	LFRAME#	4	NC
5	RST#	6	+5V
7	LAD3	8	LAD2
9	+3.3V	10	LAD1
11	LAD0	12	GND
13	SMBCLK	14	SMBDAT
15	+3.3V_SB	16	SERIRQ
17	GND	18	CLKRUN#
19	LPCPD#	20	LDREQ#

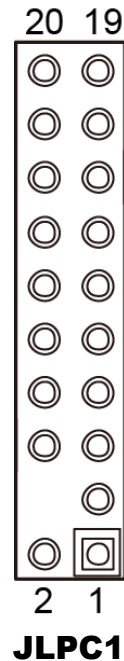

3.5.29 Flash Descriptor Override Selection

Jumper Location: JP7

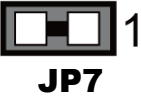
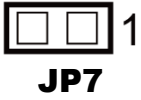

Description: Flash Descriptor Override Selection

SELECTION	JUMPER SETTING	JUMPER ILLUSTRATION
Enable	Close	 1 JP7
Disable	<i>Open (Default Setting)</i>	 1 JP7

3.5.30 VCCIO Voltage Selection

Jumper Location: JP17



Description: VCCIO Voltage Selection

SELECTION	JUMPER SETTING	JUMPER ILLUSTRATION
0.95V	<i>2-3 (Default Setting)</i>	1  1 JP17
1.0V	1-2	1  1 JP17

3.5.31 BIOS Recovery Mode Selection

Jumper Location: JP4

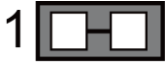
Description: BIOS Recovery Mode Selection

SELECTION	JUMPER SETTING	JUMPER ILLUSTRATION
Normal	<i>Close (Default Setting)</i>	 <p>JP4</p>
Recovery	Open	 <p>JP4</p>

3.5.32 Clear CMOS Data Selection

Jumper Location: CMOS1

Description: Clear CMOS Data Selection

- Step 1. Remove the main power of the PC.
- Step 2. Close **CMOS1** (pins 1-2) for 6 seconds by a cap.
- Step 3. Remove the cap which is just used on **CMOS1** (1-2), so that **CMOS1** returns to “OPEN”.
- Step 4. Power on the PC and the PC will then auto-reboot for once in order to set SoC’s register.
- Step 5. Done!

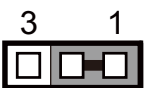
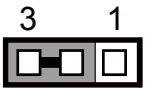
SELECTION	JUMPER SETTING	JUMPER ILLUSTRATION
Normal	<i>1-2 (Default Setting)</i>	 <p>CMOS1</p>
Clear CMOS	2-3	 <p>CMOS1</p>

4 Software Utilities

This chapter provides the detailed information that guides users to install driver utilities for the system. The following topics are included:

- Installing Intel® Chipset Software Installation Utility
- Installing Intel® Management Engine Components Installer Driver Utility
- Installing Intel® USB 3.0 Extensible Host Controller Driver Utility
- Installing RAID Driver Utility (Only for Q170 SKU, optional)
- Installing Graphics Driver Utility
- Installing LAN Driver Utility
- Installing Sound Driver Utility

4.1 Introduction

Enclosed with the EL1092 Series package is our driver utilities contained in a DVD-ROM disk. Refer to the following table for driver locations:

Filename (Assume that DVD ROM drive is D :)	Purpose	OS			
		DOS	Win7	Win8.1	Win10
D:\H110\Driver\Flash BIOS	For BIOS update utility	✓	X	X	X
D:\H110\Driver\Platform\Win7(32-bit)\Main Chip	Intel® Chipset Device Software installer	X	✓	✓	✓
D:\H110\Driver\Platform\Win7(32-bit)\Graphic	Intel® HD Graphics installer	X	✓	✓	✓
D:\H110\Driver\Platform\Win7(32-bit)\LAN	Intel® Network Connections Software	X	✓	✓	✓
D:\H110\Driver\Platform\Win7(32-bit)\Sound	Realtek High Definition Audio System Software	X	✓	✓	✓
D:\H110\Driver\Platform\Win7(32-bit)\USB3.0	Intel® USB 3.0 eXtensible Host Controller	X	✓	✓	✓
D:\H110\Driver\Platform\Win7(32-bit)\ME	Intel® Management Engine Components installer	X	✓	✓	✓
D:\H110\Driver\Platform\Win7(64-bit)\Main Chip	Intel® Chipset Device Software installer	X	✓	✓	✓
D:\H110\Driver\Platform\Win7(64-bit)\Graphic	Intel® HD Graphics installer	X	✓	✓	✓
D:\H110\Driver\Platform\Win7(64-bit)\LAN	Intel® Network Connections Software	X	✓	✓	✓
D:\H110\Driver\Platform\Win7(64-bit)\Sound	Realtek High Definition Audio System Software	X	✓	✓	✓
D:\H110\Driver\Platform\Win7(64-bit)\USB3.0	Intel® USB 3.0 eXtensible Host Controller	X	✓	✓	✓
D:\H110\Driver\Platform\Win7(64-bit)\ME	Intel® Management Engine Components installer	X	✓	✓	✓
D:\H110\Driver\Platform\Win8.1(64-bit)\Main Chip	Intel® Chipset Device Software installer	X	✓	✓	✓
D:\H110\Driver\Platform\Win8.1(64-bit)\ Graphic	Intel® HD Graphics installer	X	✓	✓	✓
D:\H110\Driver\Platform\Win8.1(64-bit)\LAN	Intel® Network Connections Software	X	✓	✓	✓
D:\H110\Driver\Platform\Win8.1(64-bit)\Sound	Realtek High Definition Audio System Software	X	✓	✓	✓
D:\H110\Driver\Platform\Win8.1(64-bit)\USB3.0	Intel® USB 3.0 eXtensible Host Controller	X	✓	✓	✓
D:\H110\Driver\Platform\Win8.1(64-bit)\ME	Intel® Management Engine Components installer	X	✓	✓	✓

Filename (Assume that DVD ROM drive is D :)	Purpose	OS			
		DOS	Win7	Win8.1	Win10
Win8.1(64-bit)\ME	Components installer				
D:\H110\Driver\Platform\Win10(64-bit)\Main Chip	Intel® Chipset Device Software installer	X	✓	✓	✓
D:\H110\Driver\Platform\Win10(64-bit)\ Graphic	Intel® HD Graphics installer	X	✓	✓	✓
D:\H110\Driver\Platform\Win10(64-bit)\LAN	Intel® Network Connections Software	X	✓	✓	✓
D:\H110\Driver\Platform\Win10(64-bit)\Sound	Realtek High Definition Audio System Software	X	✓	✓	✓
D:\H110\Driver\Platform\Win10(64-bit)\USB3.0	Intel® USB 3.0 eXtensible Host Controller	X	✓	✓	✓
D:\H110\Driver\Platform\Win10(64-bit)\ME	Intel® Management Engine Components installer	X	✓	✓	✓
D:\Q170\Driver\Flash BIOS	For BIOS update utility	✓	X	X	X
D:\Q170\Driver\Platform\Win7(32-bit)\Main Chip	Intel® Chipset Device Software installer	X	✓	✓	✓
D:\Q170\Driver\Platform\Win7(32-bit)\ Graphic	Intel® HD Graphics installer	X	✓	✓	✓
D:\Q170\Driver\Platform\Win7(32-bit)\LAN	Intel® Network Connections Software	X	✓	✓	✓
D:\Q170\Driver\Platform\Win7(32-bit)\Sound	Realtek High Definition Audio System Software	X	✓	✓	✓
D:\Q170\Driver\Platform\Win7(32-bit)\USB3.0	Intel® USB 3.0 eXtensible Host Controller	X	✓	✓	✓
D:\Q170\Driver\Platform\Win7(32-bit)\RAID	Intel® Rapid Storage Technology (Intel® RST)	X	✓	✓	✓
D:\Q170\Driver\Platform\Win7(32-bit)\ME	Intel® Management Engine Components installer	X	✓	✓	✓
D:\Q170\Driver\Platform\Win7(64-bit)\Main Chip	Intel® Chipset Device Software installer	X	✓	✓	✓
D:\Q170\Driver\Platform\Win7(64-bit)\ Graphic	Intel® HD Graphics installer	X	✓	✓	✓
D:\Q170\Driver\Platform\Win7(64-bit)\LAN	Intel® Network Connections Software	X	✓	✓	✓
D:\Q170\Driver\Platform\Win7(64-bit)\Sound	Realtek High Definition Audio System Software	X	✓	✓	✓
D:\Q170\Driver\Platform\Win7(64-bit)\USB3.0	Intel® USB 3.0 eXtensible Host Controller	X	✓	✓	✓
D:\Q170\Driver\Platform\Win7(64-bit)\RAID	Intel® Rapid Storage Technology (Intel® RST)	X	✓	✓	✓
D:\Q170\Driver\Platform\Win7(64-bit)\ME	Intel® Management Engine Components installer	X	✓	✓	✓

Filename (Assume that DVD ROM drive is D :)	Purpose	OS			
		DOS	Win7	Win8.1	Win10
D:\Q170\Driver\Platform\Win8.1(64-bit)\Main Chip	Intel® Chipset Device Software installer	X	✓	✓	✓
D:\Q170\Driver\Platform\Win8.1(64-bit)\ Graphic	Intel® HD Graphics installer	X	✓	✓	✓
D:\Q170\Driver\Platform\Win8.1(64-bit)\LAN	Intel® Network Connections Software	X	✓	✓	✓
D:\Q170\Driver\Platform\Win8.1(64-bit)\Sound	Realtek High Definition Audio System Software	X	✓	✓	✓
D:\Q170\Driver\Platform\Win8.1(64-bit)\USB3.0	Intel® USB 3.0 eXtensible Host Controller	X	✓	✓	✓
D:\Q170\Driver\Platform\Win8.1(64-bit)\RAID	Intel® Rapid Storage Technology (Intel® RST)	X	✓	✓	✓
D:\Q170\Driver\Platform\Win8.1(64-bit)\ME	Intel® Management Engine Components installer	X	✓	✓	✓
D:\Q170\Driver\Platform\Win10(64-bit)\Main Chip	Intel® Chipset Device Software installer	X	✓	✓	✓
D:\Q170\Driver\Platform\Win10(64-bit)\ Graphic	Intel® HD Graphics installer	X	✓	✓	✓
D:\Q170\Driver\Platform\Win10(64-bit)\LAN	Intel® Network Connections Software	X	✓	✓	✓
D:\Q170\Driver\Platform\Win10(64-bit)\Sound	Realtek High Definition Audio System Software	X	✓	✓	✓
D:\Q170\Driver\Platform\Win10(64-bit)\USB3.0	Intel® USB 3.0 eXtensible Host Controller	X	✓	✓	✓
D:\Q170\Driver\Platform\Win10(64-bit)\RAID	Intel® Rapid Storage Technology (Intel® RST)	X	✓	✓	✓
D:\Q170\Driver\Platform\Win10(64-bit)\ME	Intel® Management Engine Components installer	X	✓	✓	✓

X : Not support

✓: Support

Note: Install the driver utilities immediately after the OS installation is completed.

4.2 Installing Intel® Chipset Software Installation Utility

4.2.1 Introduction

The Intel® Chipset Software Installation Utility installs the Windows *.INF files to the target system. These files outline to the operating system how to configure the Intel chipset components in order to ensure that the following functions work properly:

- Core PCI and ISAPNP Services
- PCIe Support
- SATA Storage Support
- USB Support
- Identification of Intel® Chipset Components in the Device Manager

4.2.2 Intel® Chipset Software Installation Utility

The utility pack is to be installed only for Windows® 7/8.1/10 series, and it should be installed immediately after the OS installation is finished. Please follow the steps below:

- 1** Connect the USB DVD-ROM device to EL1092 and insert the driver disk.
- 2** Enter the **Main Chip** folder where the Chipset driver is located.
- 3** Select Windows 7 (32/64-bit) / Windows 8.1 (64-bit) / Windows 10 (64-bit) for your OS platform.
- 4** Click the chipset driver installation file for driver installation.
- 5** Follow the on-screen instructions to install the driver.
- 6** Once the installation is completed, shut down the system and restart EL1092 for the changes to take effect.

4.3 Intel® Management Engine Components Installer Installation

For Windows 7 only. Pre-install Microsoft's Kernel-Mode Driver Framework (KMDF) version 1.11 before you install the Intel® Management Engine Components Installer (ME) in order to avoid errors in Device Manager.

Installation Instructions for Kernel-Mode Driver Framework (KMDF)

To install the Kernel-Mode Driver Framework (KMDF), follow the steps below:

- 1** Insert the driver disk into a DVD-ROM device.
- 2** (For Windows 7 only) Enter the KMDF folder where the installation driver file is located.
- 3** (For Windows 7 only) Click the Setup kmdf-1.11.exe file for driver installation.

Installation Instructions for Intel® Management Engine Components Installer

- 1** Connect the USB DVD-ROM device to EL1092 and insert the driver disk.
- 2** Enter the **ME Installation Driver** folder where the driver is located.
- 3** Select Windows 7 (32/64-bit) / Windows 8.1 (64-bit) / Windows 10 (64-bit) for your OS platform.
- 4** Click **SetupME.exe** file for ME driver installation.
- 5** Follow the on-screen instructions to complete the installation.
- 6** Once the installation is completed, shut down the system and restart EL1092 for the changes to take effect.

4.4 Intel® USB 3.0 eXtensible Host Controller Utility

Intel® USB 3.0 eXtensible Host Controller Driver supports the following Intel® Chipsets/Processors:

- Intel® 8 Series/C220 series Chipset Family
- Intel® 4th Generation Core™ Processors
- Intel® C610 series Chipset Family
- Intel® 9 Series Chipset Family
- Intel® Pentium® Processor or Intel® Celeron® Processor N- & J-Series
- Intel® 5th generation Intel® Core™ Processors
- Intel® Core™ M Processor
- Intel® 6th generation Intel® Core™ processors
- Intel® 100 Series Chipset Family

To install the utility, follow the steps below:

- 1** Insert the driver disk into a DVD-ROM device.
- 2** Under Windows system, go to the directory where the driver is located.
- 3** Run the application with administrative privileges.

4.5 Installing RAID Driver Utility (Only for Q170, Optional)

INTEL® Rapid Storage Technology Option ROM

The Intel® Rapid Storage Technology option ROM provides the following:

- Pre-operating system user interface for RAID volume management.
- Ability to create, delete and reset RAID volumes
- RAID recovery

User Interface

To enter the Intel® Rapid Storage Technology option ROM user interface, press Ctrl-I when prompted during the Power-On Self-Test (POST).

Option ROM prompt:

```
Intel(R) Rapid Storage Technology - Option ROM - 10.5.0.1034
Copyright(C) 2003-11 Intel Corporation. All Rights Reserved.

RAID Volumes:
None defined.

Physical Devices:
Port Device Model Serial # Size Type/Status(Vol ID)
2 WDC WD1600AAJS-7 WD-WMAP9D045721 149.0GB Non-RAID Disk
3 WDC WD1600AAJS-7 WD-WMAP9D046479 149.0GB Non-RAID Disk
Press <CTRL-I> to enter Configuration Utility...
```

In the user interface, the hard drive(s) and hard drive information listed for your system will differ from the example in the figure below:

Option ROM user interface:

```
Intel(R) Rapid Storage Technology - Option ROM - 10.5.0.1034
Copyright(C) 2003-11 Intel Corporation. All Rights Reserved.
[ MAIN MENU ]
1. Create RAID Volume
2. Delete RAID Volume
3. Reset Disks to Non-RAID
4. Recovery Volume Options
5. Acceleration Options
6. Exit
[ DISK/VOLUME INFORMATION ]
RAID Volumes:
None defined.

Physical Devices:
Port Device Model Serial # Size Type/Status(Vol ID)
0 WDC WD1600AAJS-7 WD-WMAP9D045633 149.0GB Non-RAID Disk
2 WDC WD1600AAJS-7 WD-WMAP9D045721 149.0GB Non-RAID Disk
3 WDC WD1600AAJS-7 WD-WMAP9D046479 149.0GB Non-RAID Disk

[↑↓]-Select [ESC]-Exit [ENTER]-Select Menu
```

Installing RAID Driver Utility (Only for Q170, Optional)

The Intel[®] Rapid Storage Technology (Intel[®] RST) driver supports RAID 0, 1 in Q170 SKU only for 2 x 2.5” SATAIII HDD/SSD. To install the RAID driver utility, follow the steps below:

- 1** Connect the USB DVD-ROM device to EL1092 and insert the driver disk.
- 2** Enter the **RST** folder where the driver is located.
- 3** Select Windows 7 (32/64-bit) / Windows 8.1 (64-bit) / Windows 10 (64-bit) for your OS platform.
- 4** Click **SetupRST.exe** driver installation file for driver installation.
- 5** Follow the on-screen instructions to complete the installation.
- 6** Once the installation is completed, shut down the system and restart EL1092 for the changes to take effect.

Note: The RAID driver utility is not supported for H110 SKU.

4.6 Installing Graphics Driver Utility

The graphics interface embedded in EL1092 can support a wide range of display types. You can have dual displays via HDMI / DVI-I ports and make the system work simultaneously.

To install the Graphics driver utility, follow the steps below:

- 1** Connect the USB DVD-ROM device to EL1092 and insert the driver disk.
- 2** Enter the **Graphic** folder where the driver is located.
- 3** Select Windows 7 (32/64-bit) / Windows 8.1 (64-bit) / Windows 10 (64-bit) for your OS platform.
- 4** Click the graphics driver installation file for driver installation.
- 5** Follow the on-screen instructions to complete the installation.
- 6** Once the installation is completed, shut down the system and restart EL1092 for the changes to take effect.

4.7 Installing LAN Driver Utility

Enhanced with LAN function, EL1092 supports various network adapters. To install the LAN Driver, follow the steps below:

- 1** Connect the USB DVD-ROM device to EL1092 and insert the driver disk.
- 2** Enter the **LAN** folder where the driver is located.
- 3** Select Windows 7 (32/64-bit) / Windows 8.1 (64-bit) / Windows 10 (64-bit) for your OS platform.
- 4** Click the LAN driver installation file for driver installation.
- 5** Follow the on-screen instructions to complete the installation.
- 6** Once the installation is completed, shut down the system and restart EL1092 for the changes to take effect.

For more details on the installation procedure, refer to the README.txt file that you can find on LAN Driver Utility.

4.8 Installing Sound Driver Utility

The sound function enhanced in this system is fully compatible with Windows® 7/8.1/10 series.

To install the Sound Driver, follow the steps below:

- 1** Connect the USB DVD-ROM device to EL1092 and insert the driver disk.
- 2** Open the **Sound** folder where the driver is located.
- 3** Select Windows 7 (32/64-bit) / Windows 8.1 (64-bit) / Windows 10 (64-bit) for your OS platform.
- 4** Click the Sound driver installation file for driver installation.
- 5** Follow the on-screen instructions to complete the installation.
- 6** Once the installation is completed, shut down the system and restart EL1092 for the changes to take effect.

5

BIOS SETUP

This chapter guides users how to configure the basic system configurations via the BIOS Setup Utilities. The information of the system configuration is saved in battery-backed CMOS RAM and BIOS NVRAM so that the Setup information is retained when the system is powered off. The BIOS Setup Utilities consist of the following menu items:

- Accessing Setup Utilities
- Main Menu
- Advanced Menu
- Chipset Menu
- Security Menu
- Boot Menu
- Save & Exit Menu

5.1 Introduction

The EL1092 System uses an AMI (American Megatrends Incorporated) Aptio BIOS that is stored in the Serial Peripheral Interface Flash Memory (SPI Flash) and can be updated. The SPI Flash contains the built-in BIOS setup program, Power-On Self-Test (POST), PCI auto-configuration utility, LAN EEPROM information, and Plug and Play support.

Aptio is AMI's BIOS firmware based on the UEFI (Unified Extensible Firmware Interface) specifications and the Intel Platform Innovation Framework for EFI. The UEFI specification defines an interface between the operating system and platform firmware. The interface consists of data tables that contain platform-related information, boot service calls, and runtime service calls that are available to the operating system and its loader. These elements have combined to provide a standard environment for booting the operating system and running pre-boot applications.

The diagram below shows the Extensible Firmware Interface's location in the software stack.

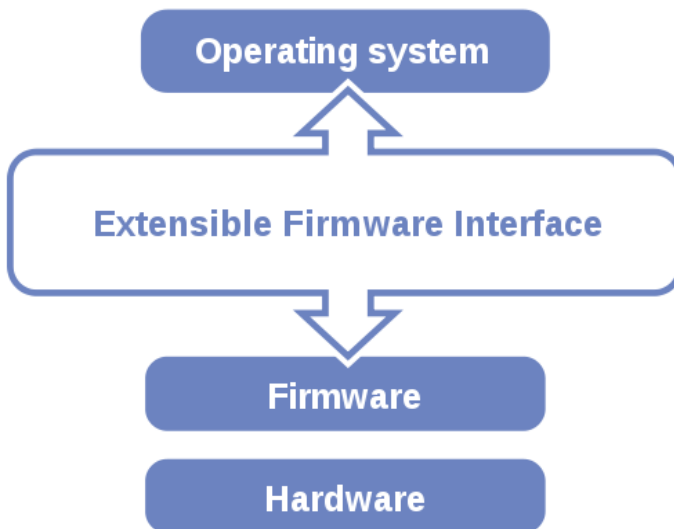

Figure 5-1. Extensible Firmware Interface Diagram

EFI BIOS provides an user interface that allows you to modify hardware configuration, e.g. change the system date and time, enable/disable a system component, determine bootable device priority, set up personal password, etc., which is convenient for engineers to perform modifications and customize the computer system and allows technicians to troubleshoot the occurred errors when the hardware is faulty.

The BIOS setup menu allows users to view and modify the BIOS settings for the computer. After the system is powered on, users can access the BIOS setup menu by pressing or <Esc> immediately while the POST message is running before the operating system is loading.

All the menu settings are described in details in this chapter.

5.2 Accessing Setup Utility

After the system is powered on, BIOS will enter the Power-On Self-Test (POST) routines and the POST message will be displayed:



Figure 5-2. POST Screen with AMI Logo

Press or <Esc> to access the Setup Utility program and the **Main** menu of the Aptio Setup Utility will appear on the screen as below:

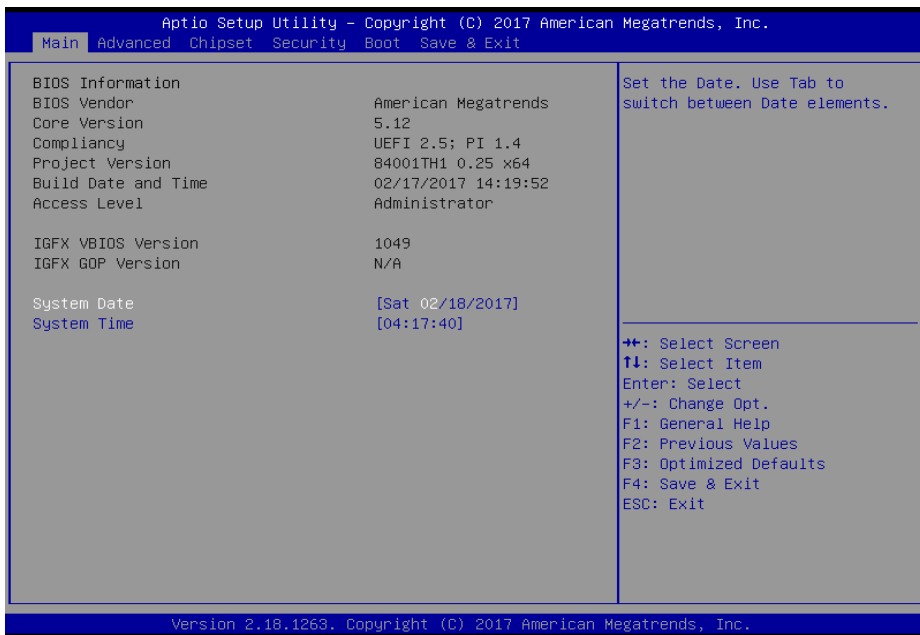

BIOS Setup Menu Initialization Screen

You may move the cursor by <↑> and <↓> keys to highlight the individual menu items. As you highlight each item, a brief description of the highlighted selection will appear on the right side of the screen.

The language of the BIOS setup menu interface and help messages are shown in US English. You may use <↑> or <↓> key to select among the items and press <Enter> to confirm and enter the sub-menu. The following table provides the list of the navigation keys that you can use while operating the BIOS setup menu.

BIOS Setup Navigation Key	Description
<←> and <→>	Select a different menu screen (move the cursor from the selected menu to the left or right).
<↑> and <↓>	Select a different item (move the cursor from the selected item upwards or downwards)
<Enter>	Execute the command or select the sub-menu.
<F2>	Load the previous configuration values.
<F3>	Load the default configuration values.
<F4>	Save the current values and exit the BIOS setup menu.
<Esc>	Close the sub-menu. Trigger the confirmation to exit BIOS setup menu.

BIOS Messages

This section describes the alert messages generated by the board's BIOS. These messages would be shown on the monitor when certain recoverable errors/events occur during the POST stage. The table below gives an explanation of the BIOS alert messages:

BIOS Message	Explanation
A first boot or NVRAM reset condition has been detected.	BIOS has been updated or the battery was replaced.
The CMOS defaults were loaded.	Default values have been loaded after the BIOS was updated or the battery was replaced.
The CMOS battery is bad or has been recently replaced.	The battery may be losing power and users should replace the battery immediately. Also, this message is displayed once the new battery is replaced.

5.3 Main

Menu Path *Main*

The **Main** menu allows you to view the BIOS Information, change the system date and time, and view the user access privilege level. Use tab to switch between date elements. Use <↑> or <↓> arrow keys to highlight the item and enter the value you want in each item. This screen also displays the BIOS version (project) and BIOS Build Date and Time.

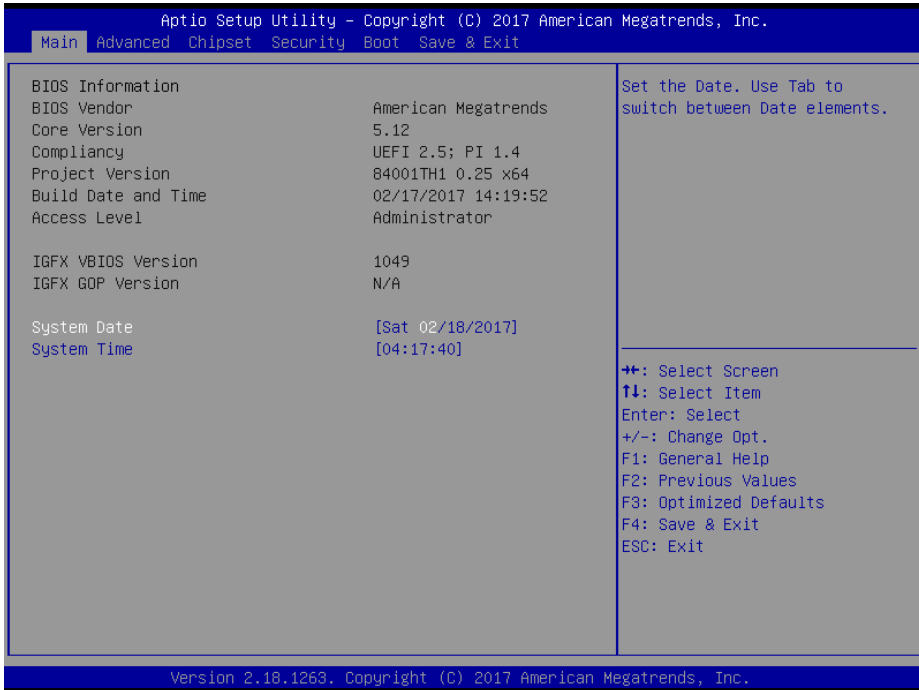

Main Screen

BIOS Setting	Options	Description/Purpose
BIOS Vendor	No changeable options	Displays the BIOS vendor.
Core Version	No changeable options	Displays the current BIOS core version.
Compliancy	No changeable options	Displays the current UEFI version.
Project Version	No changeable options	Displays the version of the BIOS currently installed on the platform.
Build Date and Time	No changeable options	Displays the date of current BIOS version.
Access Level	No changeable options	Displays the user access privilege level.
IGFX VBIOS Version	No changeable options	Displays the VBIOS version.
IGFX GOP Version	No changeable options	Displays the GOP version.

BIOS Setting	Options	Description/Purpose
System Date	Month, day, year	Sets the system date. The format is [Day Month/ Date/ Year]. Users can directly enter values or use <+> or <-> arrow keys to increase/decrease it. The "Day" is automatically changed.
System Time	Hour, minute, second	Sets the system time. The format is [Hour: Minute: Second]. Users can directly enter values or use <+> or <-> arrow keys to increase/decrease it.

5.4 Advanced

Menu Path *Advanced*

This menu provides advanced configurations such as CPU Configuration, PCH-FW Configuration, Trusted Computing, ACPI Settings, SATA Configuration, Hardware Monitor, F81866 Misc, F81866 Super IO Configuration, Network Stack Configuration and USB Configuration.

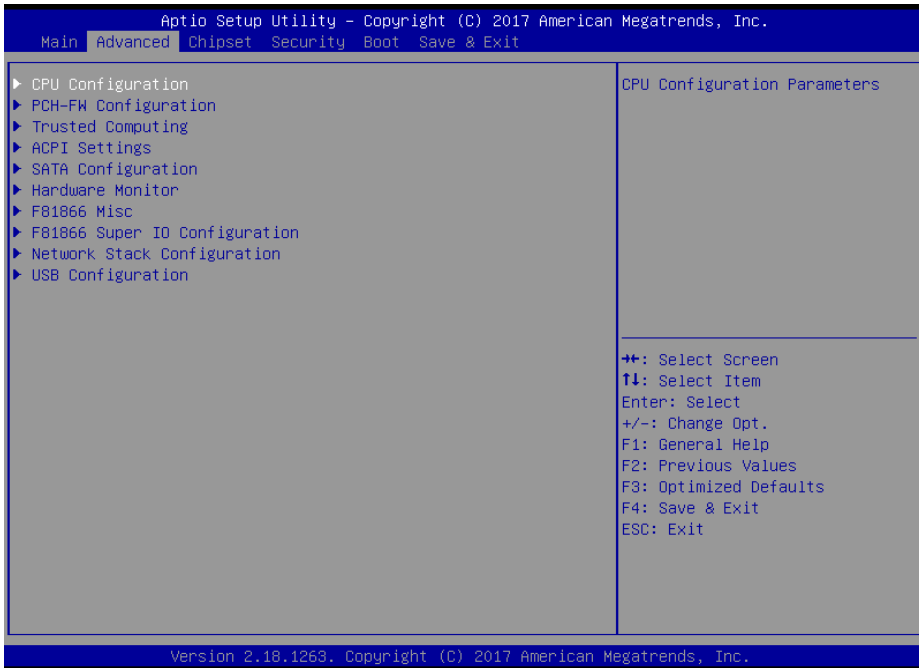

Advanced Menu Screen

BIOS Setting	Options	Description/Purpose
CPU Configuration	Sub-Menu	CPU Configuration Parameters.
PCH-FW Configuration	Sub-Menu	Management Engine Technology Parameters.
Trusted Computing	Sub-Menu	Trusted Computing Settings.
ACPI Settings	Sub-Menu	System ACPI Parameters.
SATA Configuration	Sub-Menu	SATA Device Options Settings.
Hardware Monitor	Sub-Menu	Monitor hardware status.
F81866 Misc	Sub-Menu	F81866 Watchdog Parameters.
F81866 Super IO Configuration	Sub-Menu	System Super IO Chip Parameters.
Network Stack Configuration	Sub-Menu	Network Stack Settings.
USB Configuration	Sub-Menu	USB Configuration Parameters.

5.4.1 Advanced - CPU Configuration

Menu Path *Advanced > CPU Configuration*

The **CPU Configuration** provides advanced CPU settings and some information about CPU.

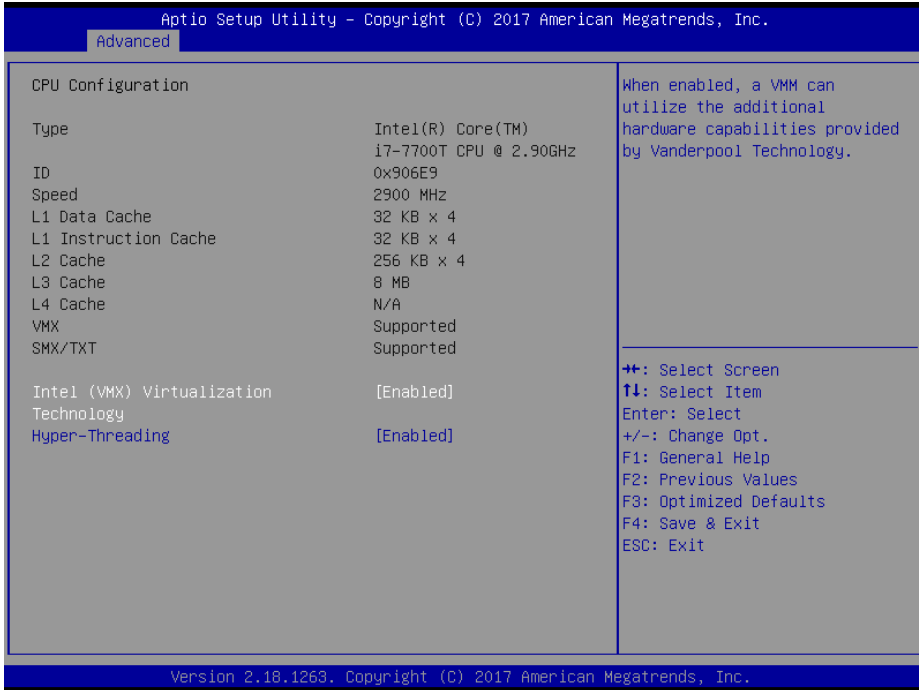

CPU Configuration Screen

BIOS Setting	Options	Description/Purpose
CPU Configuration	No changeable options	Displays CPU configuration.
Type	No changeable options	Displays CPU Core.
ID	No changeable options	Displays CPU ID number.
Speed	No changeable options	Displays the CPU speed.
L1 Data Cache	No changeable options	Displays L1 Data Cache size.
L1 Instruction Cache	No changeable options	Displays L1 Instruction Cache size.
L2 Cache	No changeable options	Displays L2 Cache size.
L3 Cache	No changeable options	Displays L3 Cache size.
L4 Cache	No changeable options	Displays L4 Cache size.
VMX	No changeable options	Supports Intel VMX Technology.
SMX/TXT	No changeable options	Reports if Intel Secure Mode Extensions Technology (SMX) /Trusted Execution Technology (TXT) is supported by the processor.

BIOS Setting	Options	Description/Purpose
Intel (VMX) Virtualization Technology	- Disabled - Enabled	When enabled, VMM can utilize the additional hardware capabilities provided by Vanderpool Technology. Previously codenamed "Vanderpool", VT-x represents Intel's technology for virtualization on the x86 platform.
Hyper-Threading	- Disabled - Enabled	When disabled, only one thread per enabled core is enabled. Hyper Threading is Intel's term for its simultaneous multithreading implementation in their CPUs. Enable this function will improve parallelization of computation performed on PC microprocessor. For each processor core that is physically present, the operating system addresses two virtual processors, and shares the workload between them when possible.

5.4.2 Advanced - PCH-FW Configuration

Menu Path Advanced > PCH-FW Configuration

The **PCH-FW** allows users to view the information about ME (Management Engine) firmware information, such as ME firmware version, firmware mode and firmware SKU.

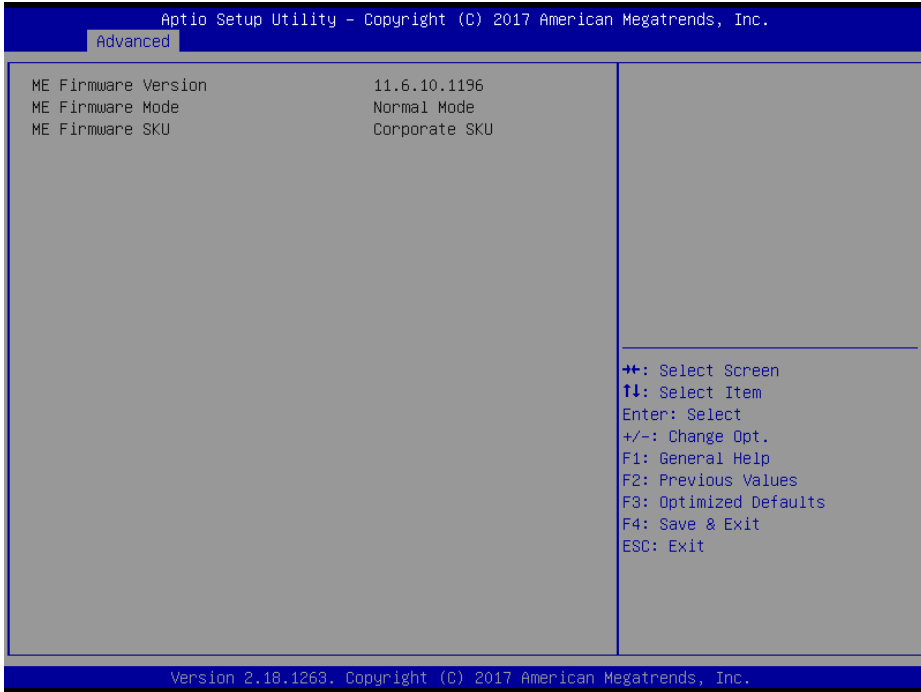

PCH-FW Configuration Screen

BIOS Setting	Options	Description/Purpose
ME FW Version	No changeable options	Displays the ME Firmware Version.
ME Firmware Mode	No changeable options	Displays the ME Firmware Mode.
ME Firmware SKU	No changeable options	Displays the ME Firmware SKU.

5.4.3 Advanced – Trusted Computing

Menu Path *Advanced > Trusted Computing*

The **Trusted Computing** allows users to enable/disable BIOS support for security device. The operating system will not show Security Device. The TCG EFI protocol and INT1A interface will not be available.

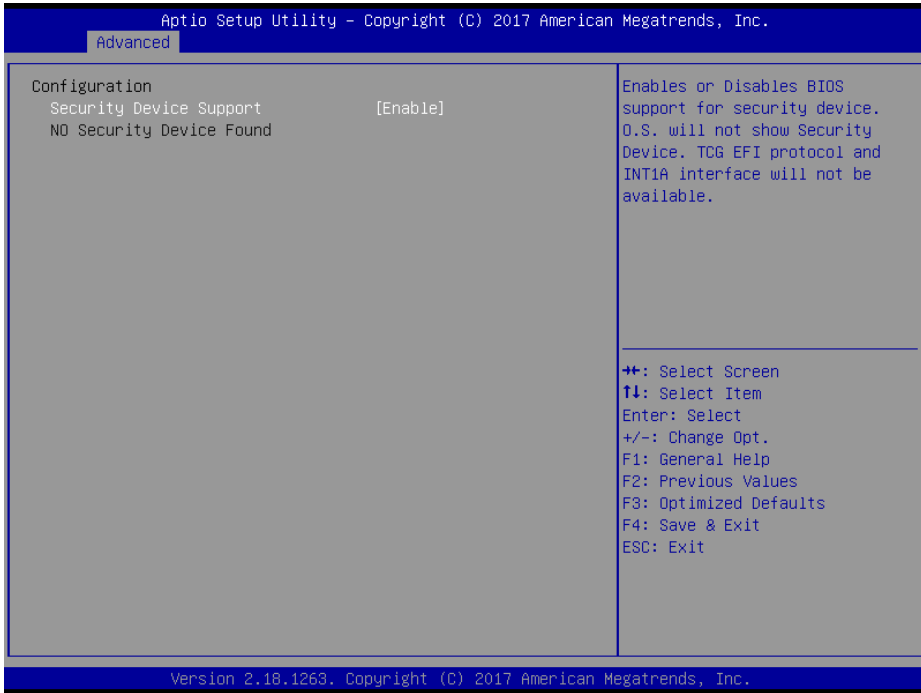

Trusted Computing Settings Screen

BIOS Setting	Options	Description/Purpose
Security Device Support	- Disable - Enable	Enables or Disables BIOS support for security device. O.S. will not show Security Device. TCG EFI Protocol and INT1A interface will not be available.

5.4.4 Advanced – ACPI Settings

Menu Path *Advanced > ACPI Settings*

The **ACPI Settings** allows users to configure relevant ACPI (Advanced Configuration and Power Management Interface) settings such as Enable/Disable Hibernation and ACPI sleep state.

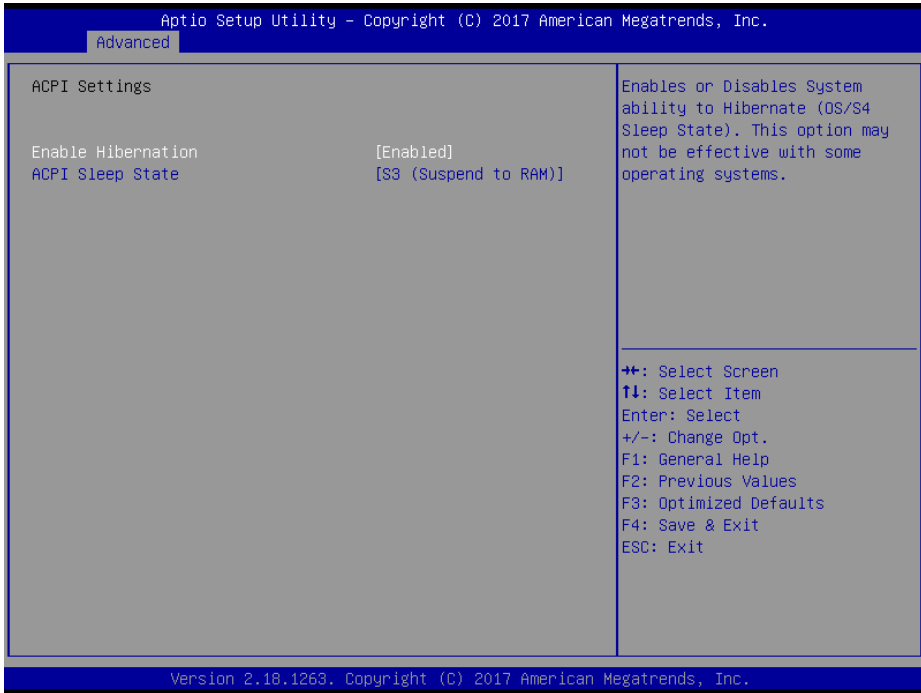

ACPI Settings Screen

BIOS Setting	Options	Description/Purpose
Enable Hibernation	- Disabled - Enabled	Enables or Disables System ability to Hibernate (OS/S4 Sleep State). This option may be not effective with some OS.
ACPI Sleep State	- Suspend Disabled - S3 (Suspend to RAM)	Selects the ACPI sleep state the system will enter when the SUSPEND button is pressed.

5.4.5 Advanced – SATA Configuration

Menu Path *Advanced > SATA Configuration*

The **SATA Configuration** allows users to enable / disable the SATA controller as well as the operational mode after the SATA controller is enabled. The following screen indicates the functions available when the SATA hard drive is set to work in AHCI mode.

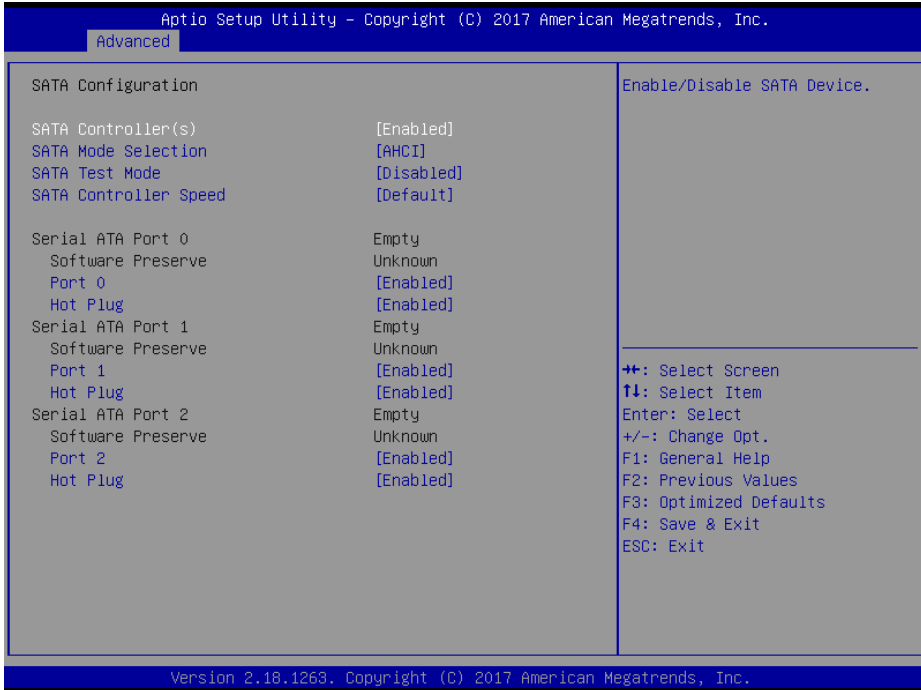

SATA Configuration Screen

BIOS Setting	Options	Description/Purpose
SATA Controller(s)	- Disabled - Enabled	Enables or Disables the on-chip SATA Device. Default: Enabled.
SATA Mode Selection	- AHCI - Intel RST Premium	Determines how SATA controller(s) operate.
Serial ATA Port 0 – 2	No changeable options	Displays the SATA device’s name.
Software Preserve	No changeable options	Indicates whether the connected SATA device supports Software Setting Preservation (SSP).
Port 0 – 2	- Disabled - Enabled	Enables or Disables SATA Port Device.
Hot Plug	- Disabled - Enabled	Enables or Disables SATA Port Device HotPlug function to designate a SATA port device as hot-pluggable.

5.4.6 Advanced – Hardware Monitor

Menu Path *Advanced > Hardware Monitor*

The **Hardware Monitor** allows users to monitor the health and status of the system such as CPU temperature, system temperature and voltage levels in supply.

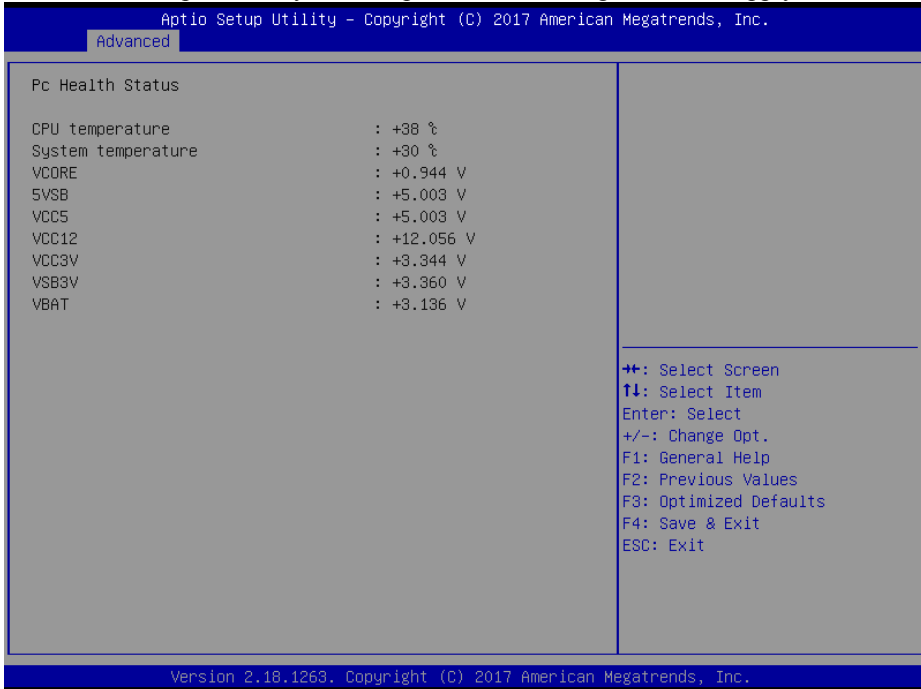

Hardware Monitor Screen

BIOS Setting	Options	Description/Purpose
CPU Temperature	No changeable options	Displays the processor's temperature.
System Temperature	No changeable options	Displays the system's temperature.
VCORE	No changeable options	Detects and displays the VCORE CPU voltage.
5VSB	No changeable options	Detects and displays VSB5V voltage.
VCC5	No changeable options	Detects and displays 5V voltage.
VCC12	No changeable options	Detects and displays 12V voltage.
VCC3V	No changeable options	Detects and displays 3V voltage.
VS3V	No changeable options	Detects and displays VSB3V voltage.
VBAT	No changeable options	Detects and displays the battery voltage.

5.4.7 Advanced – F81866 Misc Configuration

Menu Path *Advanced > F81866 Misc*

If the system hangs or fails to respond, enable the F81866 Watchdog function to trigger a system reset via the 255-level watchdog timer.

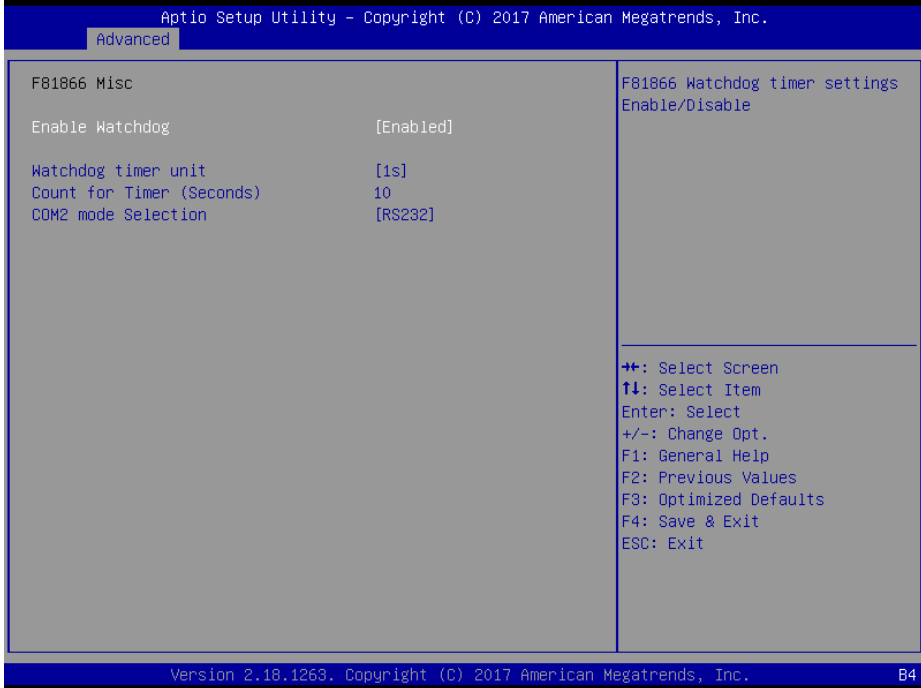

F81866 Misc Configuration Screen

BIOS Setting	Options	Description/Purpose
Enable Watchdog	- Enabled - Disabled	Enables/Disables F81866 Watchdog timer settings.
Watchdog timer unit	- 1s - 60s	Selects 1s (second) or 60s (minute) as the time unit of Watchdog timer.
Count for Timer (Seconds)	Numeric (from 1 to 255)	Sets the timeout for Watchdog timer. (Max. value: 255 seconds or minutes)
COM2 mode Selection	- RS232 - RS422 - RS485	RS232/RS422/RS485 Selection

5.4.8 Advanced – F81866 Super IO Configuration

Menu Path *Advanced > F81866 Super IO Configuration*

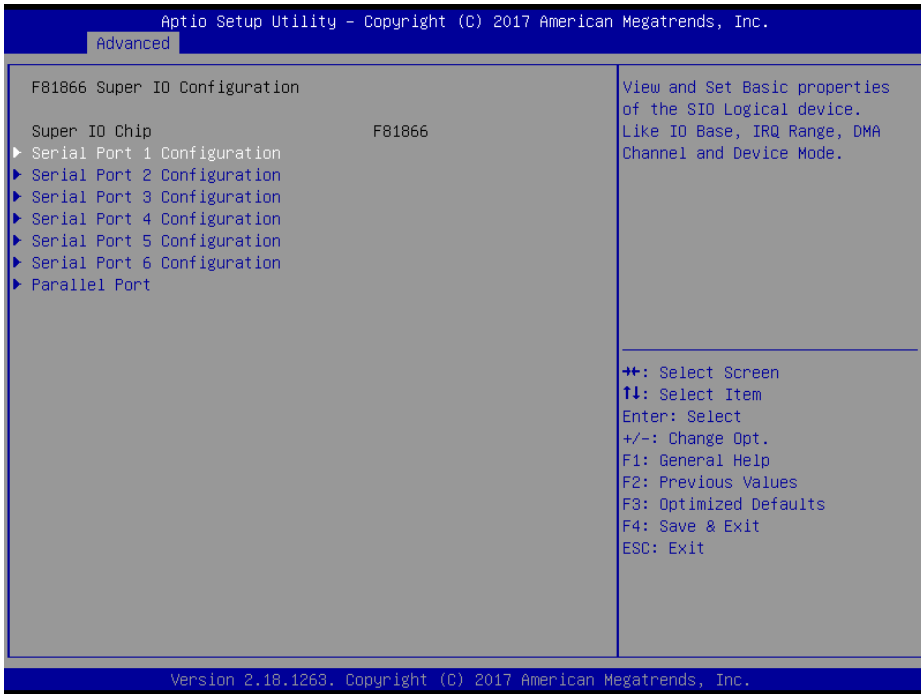

F81866 Super IO Configuration Screen

BIOS Setting	Options	Description/Purpose
Serial Port 1 Configuration	Sub-menu	Sets the parameters of Serial Port 1 (COMA).
Serial Port 2 Configuration	Sub-menu	Sets the parameters of Serial Port 2 (COMB).
Serial Port 3 Configuration	Sub-menu	Sets the parameters of Serial Port 3 (COMC).
Serial Port 4 Configuration	Sub-menu	Sets the parameters of Serial Port 4 (COMD).
Serial Port 5 Configuration	Sub-menu	Sets the parameters of Serial Port 5 (COME).
Serial Port 6 Configuration	Sub-menu	Sets the parameters of Serial Port 6 (COMF).
Parallel Port	Sub-menu	Sets the parameters of Parallel Port.

Menu Path *Advanced > F81866 Super IO Configuration >
Serial Port 1 Configuration*

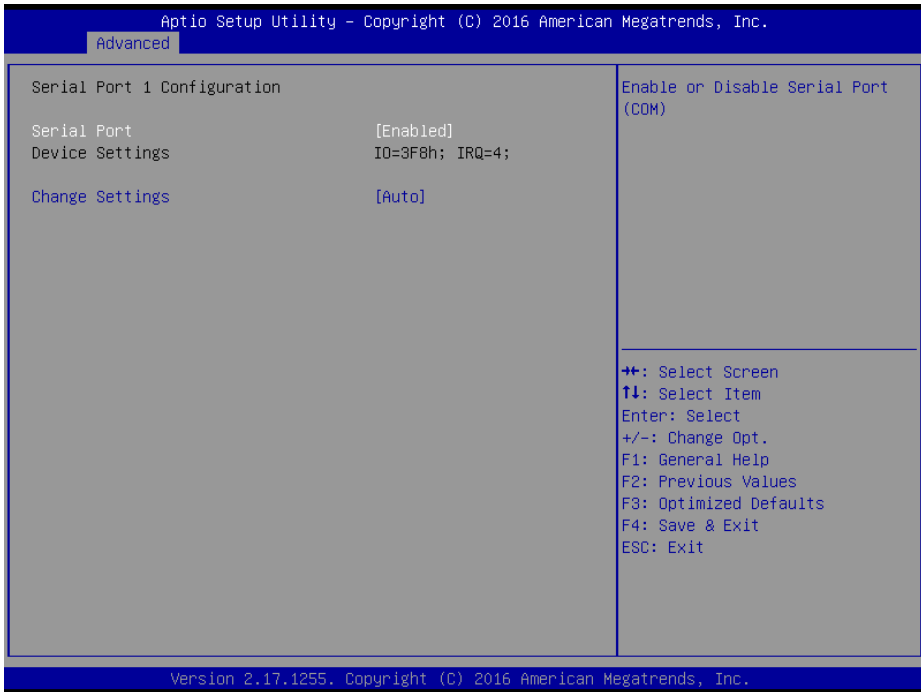

Serial Port 1 Configuration Screen

BIOS Setting	Options	Description/Purpose
Serial Port	- Disabled - Enabled	Enables or Disables Serial Port 1.
Device settings	No changeable options	Displays the current settings of Serial Port 1.
Change Settings	- Auto - IO=3F8h; IRQ=4; - IO=3F8h; IRQ=3,4,5,6,7,9,10,11,12; - IO=2F8h; IRQ=3,4,5,6,7,9,10,11,12; - IO=3E8h; IRQ=3,4,5,6,7,9,10,11,12; - IO=2E8h; IRQ=3,4,5,6,7,9,10,11,12;	Allows you to select specific IO address and IRQ for Serial Port 1.

Menu Path *Advanced > F81866 Super IO Configuration > Serial Port 2 Configuration*

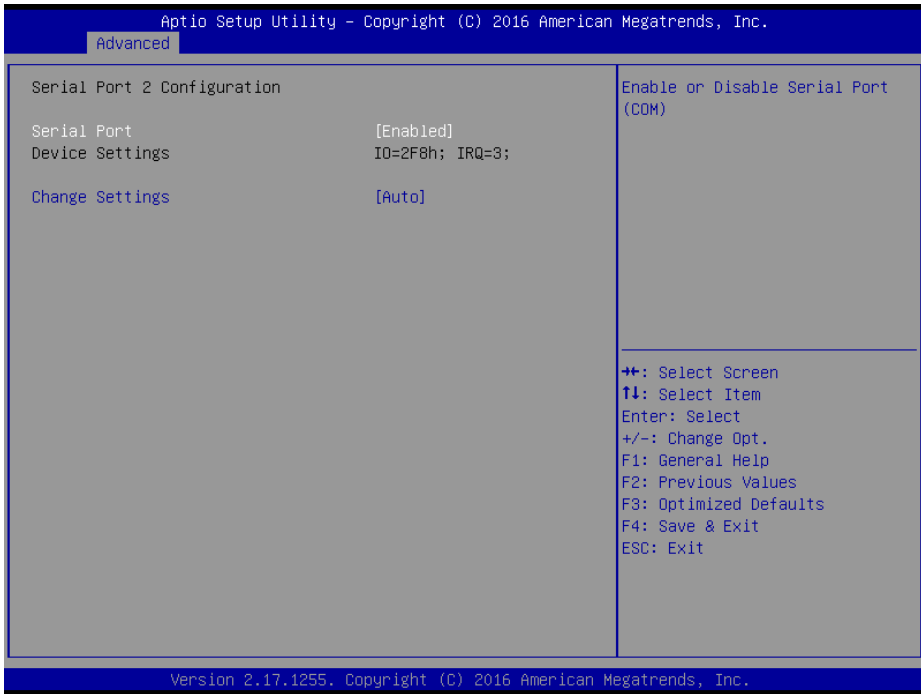

Serial Port 2 Configuration Screen

BIOS Setting	Options	Description/Purpose
Serial Port	- Disabled - Enabled	Enables or Disables Serial Port 2.
Device Settings	No changeable options	Displays the current settings of Serial Port 2.
Change Settings	- Auto - IO=2F8h; IRQ=3; - IO=3F8h; IRQ=3,4,5,6,7,9,10,11,12; - IO=2F8h; IRQ=3,4,5,6,7,9,10,11,12; - IO=3E8h; IRQ=3,4,5,6,7,9,10,11,12; - IO=2E8h; IRQ=3,4,5,6,7,9,10,11,12;	Allows you to select specific IO address and IRQ for Serial Port 2.

Menu Path *Advanced > F81866 Super IO Configuration >
Serial Port 3 Configuration*

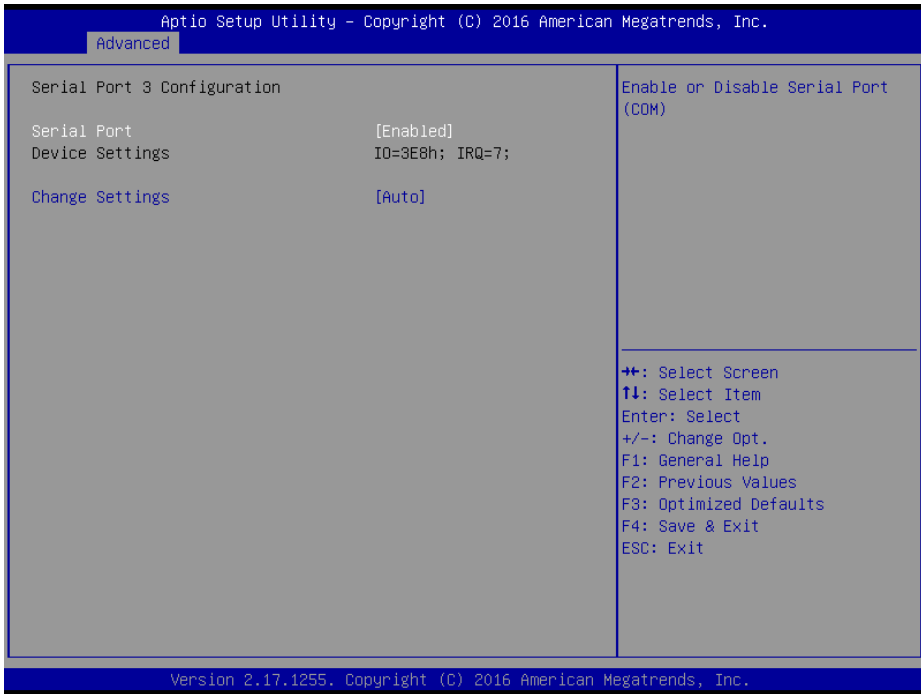

Serial Port 3 Configuration Screen

BIOS Setting	Options	Description/Purpose
Serial Port	- Disabled - Enabled	Enables or Disables Serial Port 3.
Device Settings	No changeable options	Displays the current settings of Serial Port 3.
Change Settings	- Auto - IO=3E8h; IRQ=7; - IO=3E8h; IRQ=3,4,5,6,7,9,10,11,12; - IO=2E8h; IRQ=3,4,5,6,7,9,10,11,12; - IO=2F0h; IRQ=3,4,5,6,7,9,10,11,12; - IO=2E0h; IRQ=3,4,5,6,7,9,10,11,12;	Allows you to select specific IO address and IRQ for Serial Port 3.

Menu Path *Advanced > F81866 Super IO Configuration > Serial Port 4 Configuration*

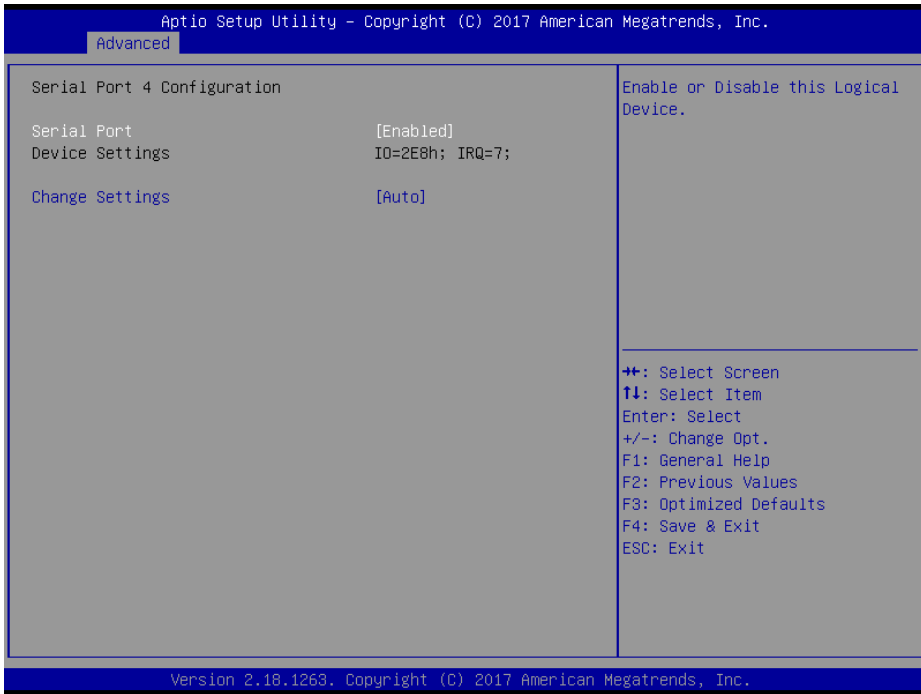

Serial Port 4 Configuration Screen

BIOS Setting	Options	Description/Purpose
Serial Port	- Disabled - Enabled	Enables or Disables Serial Port 4.
Device Settings	No changeable options	Displays the current settings of Serial Port 4.
Change Settings	- Auto - IO=2E8h; IRQ=7; - IO=3E8h; IRQ=3,4,5,6,7,9,10,11,12; - IO=2E8h; IRQ=3,4,5,6,7,9,10,11,12; - IO=2F0h; IRQ=3,4,5,6,7,9,10,11,12; - IO=2E0h; IRQ=3,4,5,6,7,9,10,11,12;	Allows you to select specific IO address and IRQ for Serial Port 4.

Menu Path *Advanced > F81866 Super IO Configuration >
Serial Port 5 Configuration*

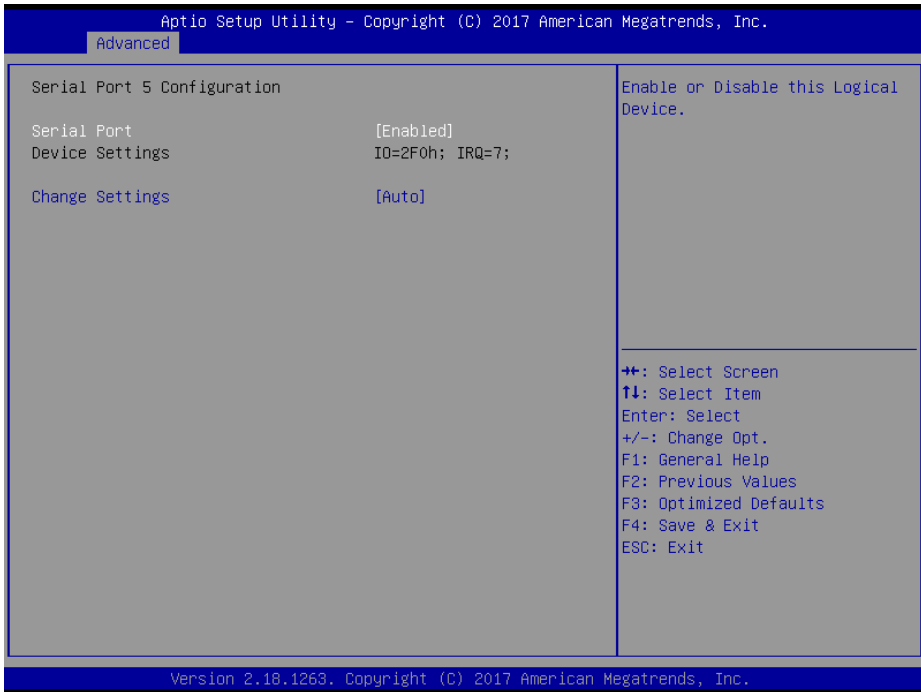

Serial Port 5 Configuration Screen

BIOS Setting	Options	Description/Purpose
Serial Port	- Disabled - Enabled	Enables or Disables Serial Port 5.
Device Settings	No changeable options	Displays the current settings of Serial Port 5.
Change Settings	- Auto - IO=2F0h; IRQ=7; - IO=3E8h; IRQ=3,4,5,6,7,9,10,11,12; - IO=2E8h; IRQ=3,4,5,6,7,9,10,11,12; - IO=2F0h; IRQ=3,4,5,6,7,9,10,11,12; - IO=2E0h; IRQ=3,4,5,6,7,9,10,11,12;	Allows you to select specific IO address and IRQ for Serial Port 5.

Menu Path *Advanced > F81866 Super IO Configuration >
Serial Port 6 Configuration*

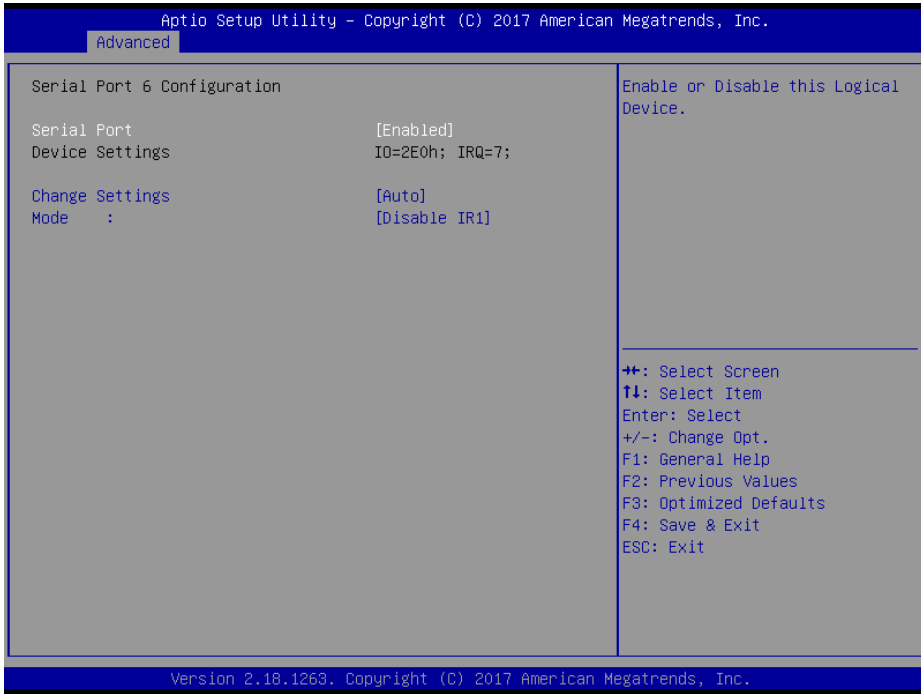

Serial Port 6 Configuration Screen

BIOS Setting	Options	Description/Purpose
Serial Port	- Disabled - Enabled	Enables or Disables Serial Port 6.
Device Settings	No changeable options	Displays the current settings of Serial Port 6.
Change Settings	- Auto - IO=2E0h; IRQ=7; - IO=3E8h; IRQ=3,4,5,6,7,9,10,11,12; - IO=2E8h; IRQ=3,4,5,6,7,9,10,11,12; - IO=2F0h; IRQ=3,4,5,6,7,9,10,11,12; - IO=2E0h; IRQ=3,4,5,6,7,9,10,11,12;	Allows you to select specific IO address and IRQ for Serial Port 6.
Mode	- Disable IR1 - Enable IR1 (pulse 1.6uS) - Enable IR1 (pulse 3/16 bit time)	Enables or Disables IR function.

Menu Path *Advanced > F81866 Super IO Configuration > Parallel Port Configuration*

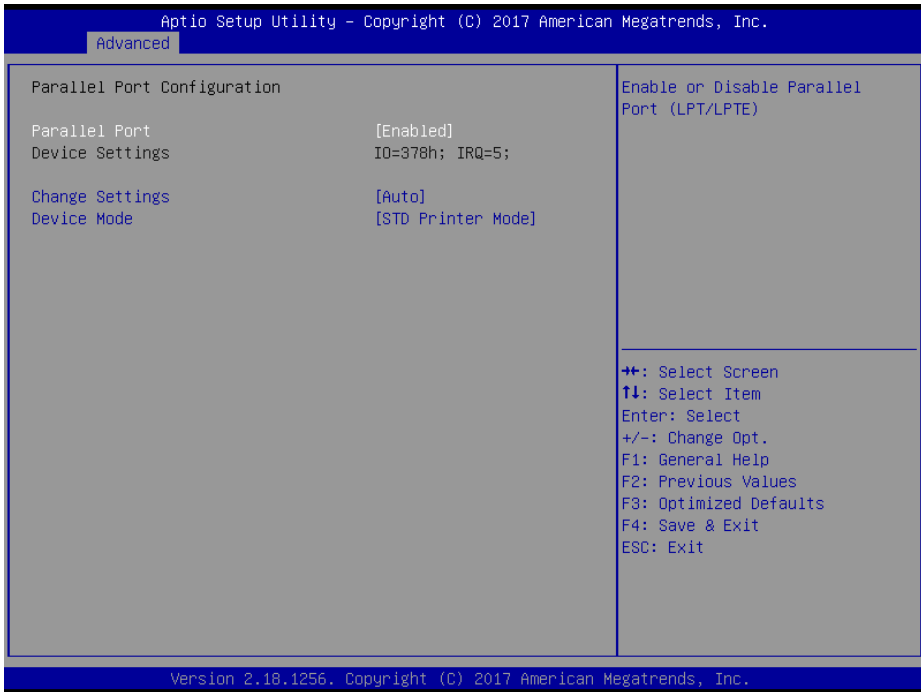

Parallel Port Configuration Screen

BIOS Setting	Options	Description/Purpose
Parallel Port	- Disabled - Enabled	Enables or Disables parallel port.
Device Settings	No changeable options	Displays the current settings of Parallel Port.
Change Settings	- Auto - IO=378h; IRQ=5; - IO=378h; IRQ=5,6,7,9,10,11,12; - IO=278h; IRQ=5,6,7,9,10,11,12; - IO=3BCh; IRQ=5,6,7,9,10,11,12;	Allows you to select specific IO address and IRQ for Parallel Port.
Mode	- STD Printer Mode - SPP Mode - EPP-1.9 and SPP Mode - EPP-1.7 and SPP Mode - ECP Mode - ECP and EPP 1.9 Mode - ECP and EPP 1.7 Mode	Allows you to change Parallel Port mode.

5.4.12 Advanced - Network Stack Configuration

Menu Path *Advanced > Network Stack Configuration*

The **Network Stack Configuration** allows users to enable/disable UEFI Network Stack, IPv4/IPv6 PXE (Pre-Boot eXecution Environment) and IPv4/IPv6 HTTP (Hypertext Transfer Protocol) support and configure PXE boot wait time and detects the media presence.

PXE allows a workstation to boot from a server on a network prior to booting the operating system on the local hard drive. A PXE-enabled workstation connects its NIC to the LAN via a jumper, which keeps the workstation connected to the network even when the power is turned off.

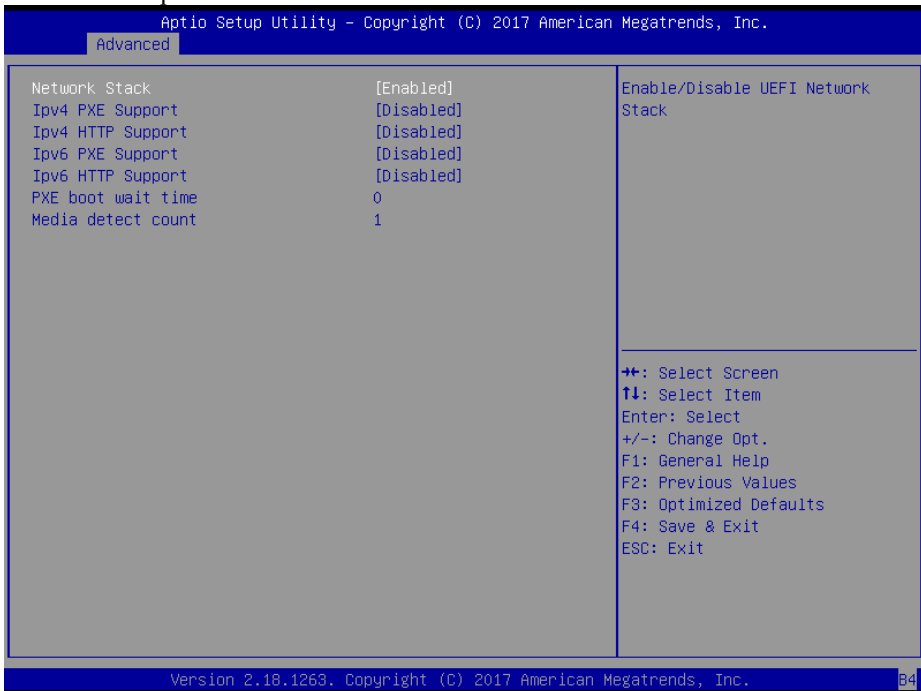

Network Stack Configuration Screen

BIOS Setting	Options	Description/Purpose
Network Stack	- Disabled - Enabled	Enables or Disables UEFI Network Stack.
Ipv4 PXE Support	- Disabled - Enabled	Enables IPv4 PXE Boot Support. If disabled, IPv4 PXE boot option will not be created.
Ipv4 HTTP Support	- Disabled - Enabled	Enables IPv4 HTTP Boot Support. If disabled, IPv4 HTTP boot option will not be created.

BIOS Setting	Options	Description/Purpose
		be created.
Ipv6 PXE Support	- Disabled - Enabled	Enables IPv6 PXE Boot Support. If disabled, IPv6 PXE boot option will not be created.
Ipv6 HTTP Support	- Disabled - Enabled	Enable IPv6 HTTP Boot Support. If disabled, IPv6 HTTP boot option will not be created.
PXE boot wait time	Numeric (from 0 to 5)	Number of seconds to wait for PXE boot to abort after the Esc key is pressed.
Media detect count	Numeric (from 1 to 50)	Number of times that the media presence will be checked.

5.4.13 Advanced – USB Configuration

Menu Path *Advanced > USB Configuration*

The **USB Configuration** allows users to configure advanced USB settings such as Legacy USB support.

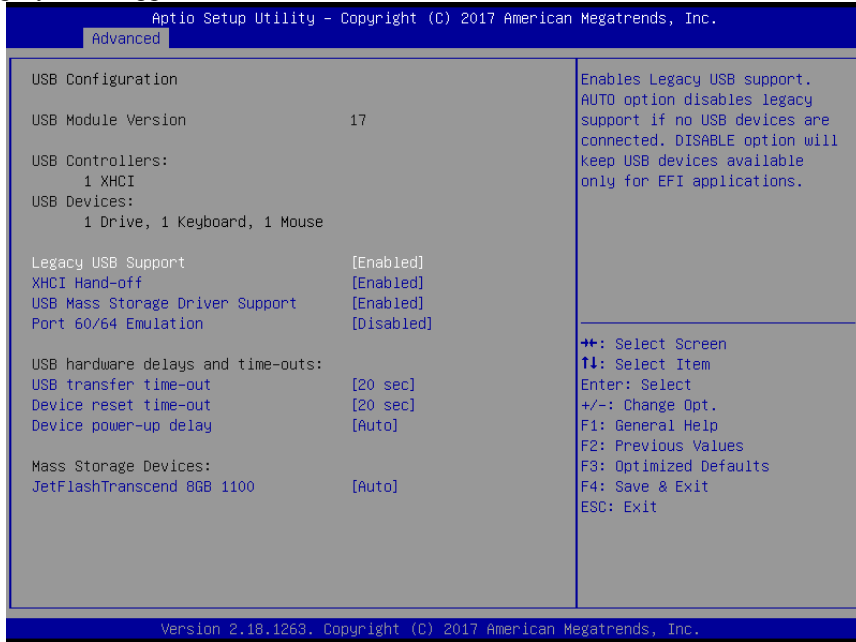

USB Configuration Screen

BIOS Setting	Options	Description/Purpose
Legacy USB Support	- Disabled - Enabled - Auto	Sets to “Enabled” if you want to use USB devices with the legacy operating systems that do not support USB.
XHCI Hand-off	- Enabled - Disabled	This is a workaround for OSEs without XHCI hand-off support.
USB Mass Storage Driver Support	- Enabled - Disabled	Enables or Disables USB mass storage driver support.
Port 60/64 Emulation	- Disabled - Enabled	Enables I/O port 60h/64h emulation support.
USB transfer time-out	1- 20 sec	The time-out value for Control, Bulk, and Interrupt transfers.
Device reset time-out	1- 20 sec	USB mass storage device Start Unit command time-out.
Device power-up delay	- Auto - Manual	Maximum time the device will take before it properly reports itself to the Host Controller.

5.5 Chipset

Menu Path *Chipset*

This menu allows users to configure advanced Chipset settings such as System Agent (SA) and PCH-IO configuration parameters.

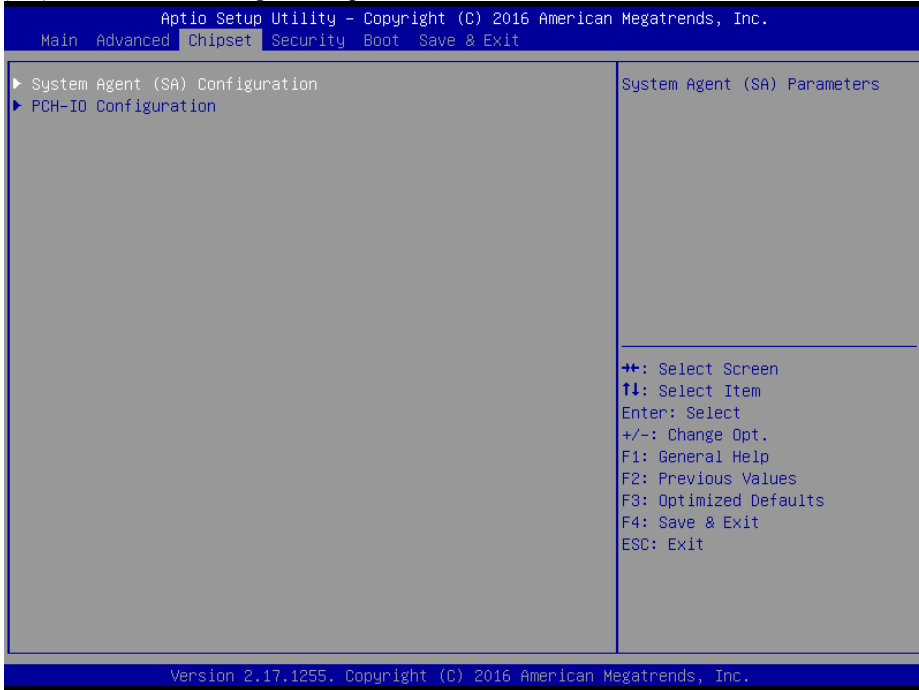

Chipset Screen

BIOS Setting	Options	Description/Purpose
System Agent (SA) Configuration	Sub-menu	System Agent (SA) parameters.
PCH-IO Configuration	Sub-menu	PCH parameters.

5.5.1 Chipset – System Agent (SA) Configuration

Menu Path *Chipset > System Agent (SA) Configuration*

The **System Agent Configuration** allows users to display DRAM information on the platform as well as configure graphics settings.

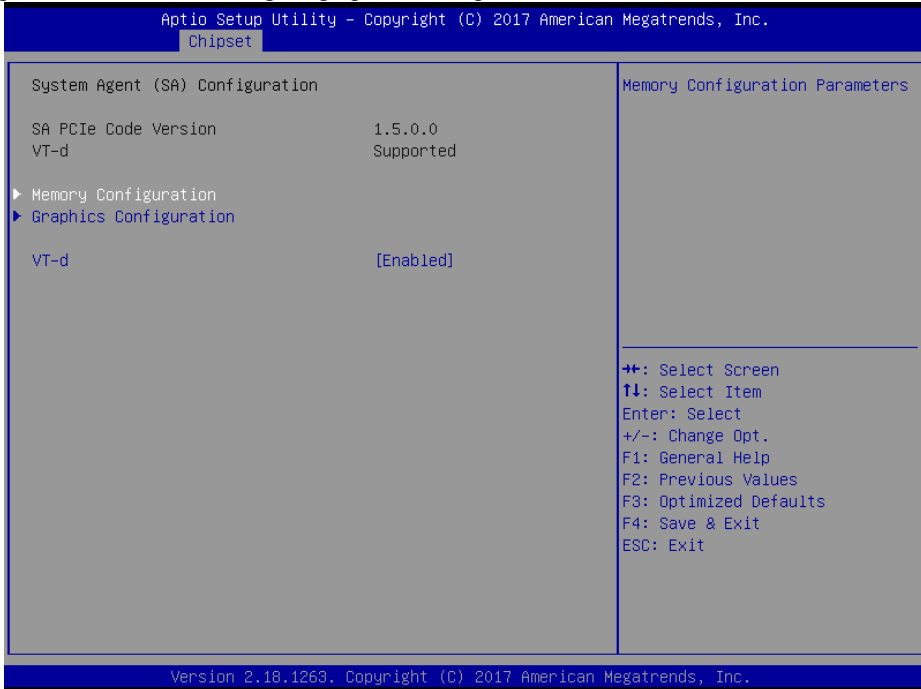

System Agent (SA) Configuration Screen

BIOS Setting	Options	Description/Purpose
System Agent (SA) Configuration	No changeable options	Configures System Agent Configuration.
SA PCIe Code Version	No changeable options	Displays the SA PCIe Code Version.
VT-d	No changeable options	Indicates whether Intel's VT-d (Virtualization Technology for Directed I/O) capability is supported. VT-d extends Intel's Virtualization Technology (VT) roadmap by providing hardware assists for virtualization solution, and helps end users improve security and reliability of the systems and also improves performance of I/O devices in virtualized environment.

BIOS Setting	Options	Description/Purpose
Memory Configuration	Sub-menu	Displays the DRAM information on the platform.
Graphics Configuration	Sub-menu	Configures Graphics Settings.
VT-d	- Disabled - Enabled	Enables or Disables VT-d function.

5.5.1.1 Chipset – SA Configuration - Memory Configuration

Menu Path *Chipset > System Agent (SA) Configuration > Memory Configuration*

The **Memory Configuration** allows users to check for the information about the memory frequency, total DRAM size, memory (RAM) timings and latency, etc.

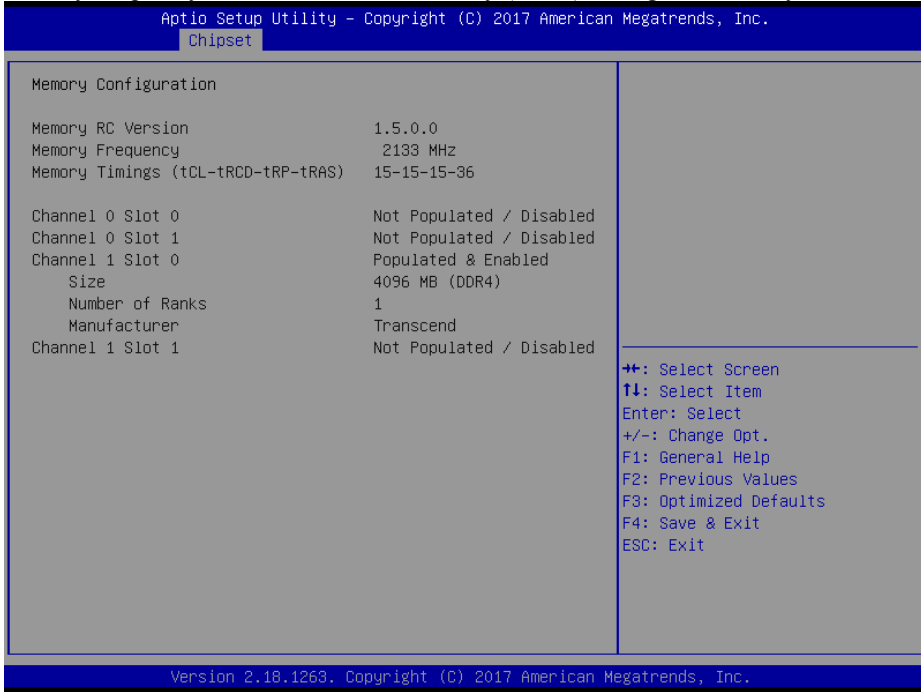

Memory Configuration Screen

BIOS Setting	Options	Description/Purpose
Memory RC Version	No changeable options	Displays the Memory RC Version.
Memory Frequency	No changeable options	Displays the Frequency of Memory.
Memory Timings (tCL-tRCD-tRP-tRAS)	No changeable options	Displays the Memory (RAM) timings and latency. <ul style="list-style-type: none"> • CAS Latency (tCL) - This is the most important memory timing. CAS stands for Column Address Strobe. If a row has already been selected, it tells us how many clock cycles we'll have to wait for a result (after sending a column address to the RAM controller).

BIOS Setting	Options	Description/Purpose
		<ul style="list-style-type: none"> • Row Address (RAS) to Column Address (CAS) Delay (tRCD) - Once we send the memory controller a row address, we'll have to wait this many cycles before accessing one of the row's columns. So, if a row hasn't been selected, this means we'll have to wait $tRCD + tCL$ cycles to get our result from the RAM. • Row Precharge Time (tRP) - If we already have a row selected, we'll have to wait this number of cycles before selecting a different row. This means it will take $tRP + tRCD + tCL$ cycles to access the data in a different row. • Row Active Time (tRAS) - This is the minimum number of cycles that a row has to be active for to ensure we'll have enough time to access the information that's in it. This usually needs to be greater than or equal to the sum of the previous three latencies ($tRAS = tCL + tRCD + tRP$).
Channel 0 Slot 0	No changeable options	Displays if Channel 0 Slot 0 is populated/enabled or not.
Channel 0 Slot 1	No changeable options	Displays if Channel 0 Slot 1 is populated/enabled or not.
Channel 1 Slot 0	No changeable options	Displays if Channel 1 Slot 0 is populated/enabled or not.
Channel 1 Slot 1	No changeable options	Displays if Channel 1 Slot 1 is populated/enabled or not.
Size	No changeable options	Displays the memory size.
Number of Ranks	No changeable options	Displays the Rank number.
Manufacturer	No changeable options	Displays the name of the memory manufacturer.

5.5.1.2 Chipset – System Agent (SA) Configuration – Graphics Configuration

Menu Path *Chipset > System Agent (SA) Configuration > Graphics Configuration*

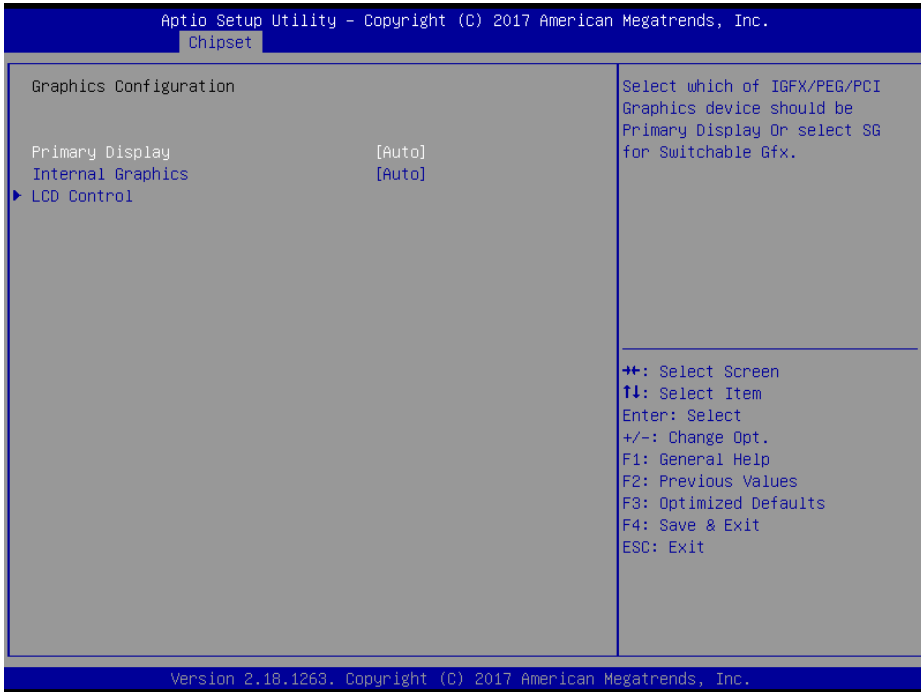

Graphics Configuration Screen

BIOS Setting	Options	Description/Purpose
Primary Display	- Auto - IGFX - PEG - PCI - SG	Selects which of IGFX/PEG/PCI Graphics device should be Primary Display or select SG for switchable Gfx.
Internal Graphics	- Auto - Disabled - Enabled	Keeps IGFX enabled based on the setup options.
LCD Control	Sub-menu	LCD Control sub-menu.

Menu Path *Chipset > System Agent (SA) Configuration > Graphics Configuration > LCD Control*

The **LCD Control** allows users to select the primary and secondary display device, configures LVDS resolution and enable/disable LVDS panel.

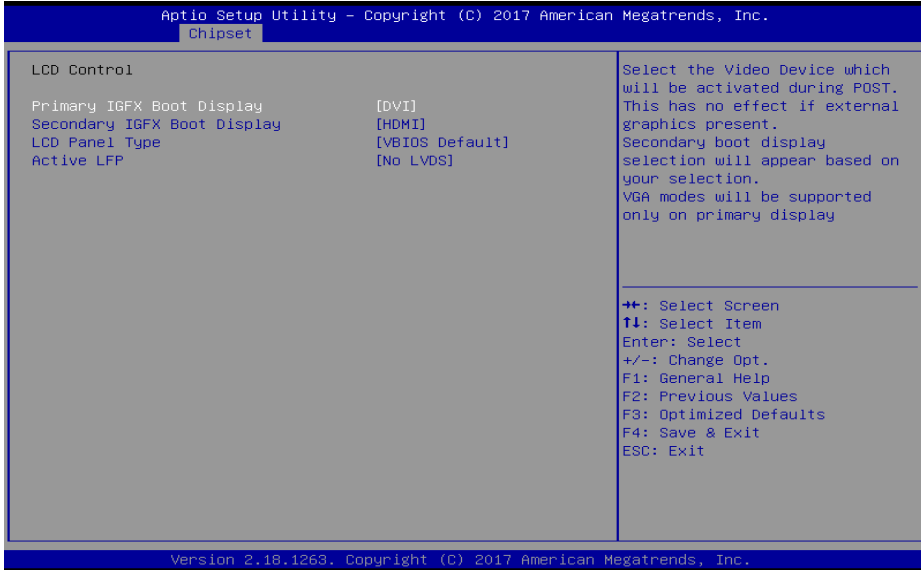

LCD Control Screen

BIOS Setting	Options	Description/Purpose
Primary IGFX Boot Display	- VBIOS default - DVI - LVDS - VGA - HDMI	Selects Primary Display device.
Secondary IGFX Boot Display	- DVI - LVDS - VGA - HDMI	Selects Secondary Display device.
LCD Panel Type	- VBIOS Default - 640x480 LVDS - 800x600 LVDS - 1024x768 LVDS - 1280x1024 LVDS - 2048x1536 LVDS - 1366x768 LVDS	Selects the LVDS resolution.
Active LFP	- No LVDS - eDP Port-A	Enables or Disables LVDS panel.

5.5.2 Chipset – PCH-IO Configuration

Menu Path *Chipset > PCH-IO Configuration*

The **PCH-IO** Configuration allows users to set PCI Express configuration parameters, enable/disable PCH LAN Controller and Wake-On-LAN function and determine the power on/off state that the system will go into following a power failure (G3 state).

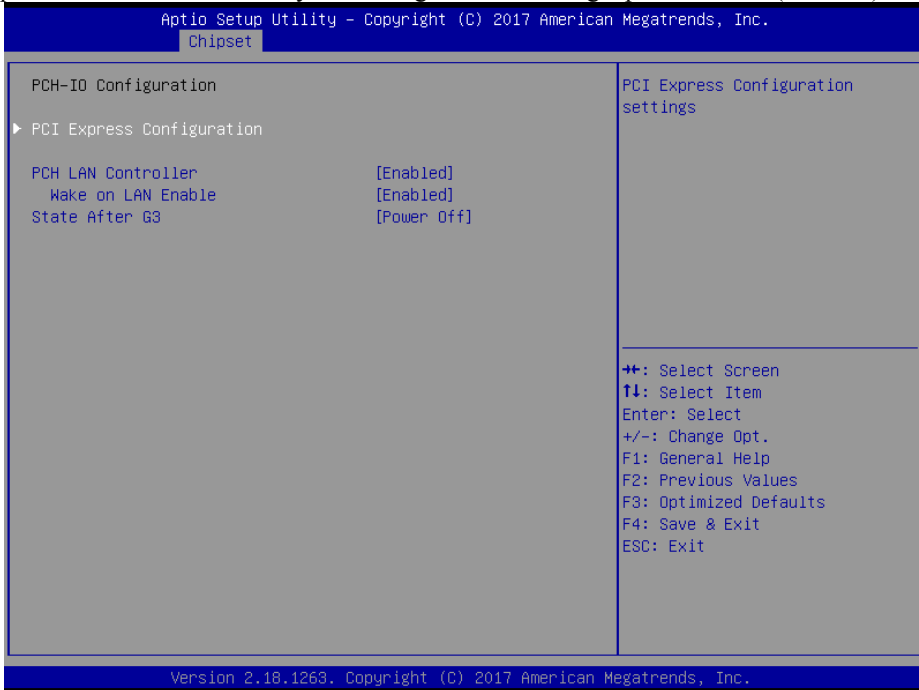

PCH-IO Configuration Screen

BIOS Setting	Options	Description/Purpose
PCI Express Configuration	Sub-menu	Configures PCI Express Configuration settings.
PCH LAN Controller	- Disabled - Enabled	Enables or Disables onboard NIC.
Wake on LAN Enable	- Disabled - Enabled	Enables or Disables integrated LAN to wake up the system. Default: Enabled.
State After G3	- Power On - Power Off	Specifies the Power On/Off state that the system will go into when the power is re-applied following a power failure (G3 state).

5.5.2.1 Chipset – PCH-IO Configuration – PCI Express Configuration

Menu Path *Chipset > PCH-IO Configuration > PCI Express Configuration*

The **PCI Express Configuration** allows users to configure PCI Express root port 1 and Mini PCI Express Ports 1-2 settings.

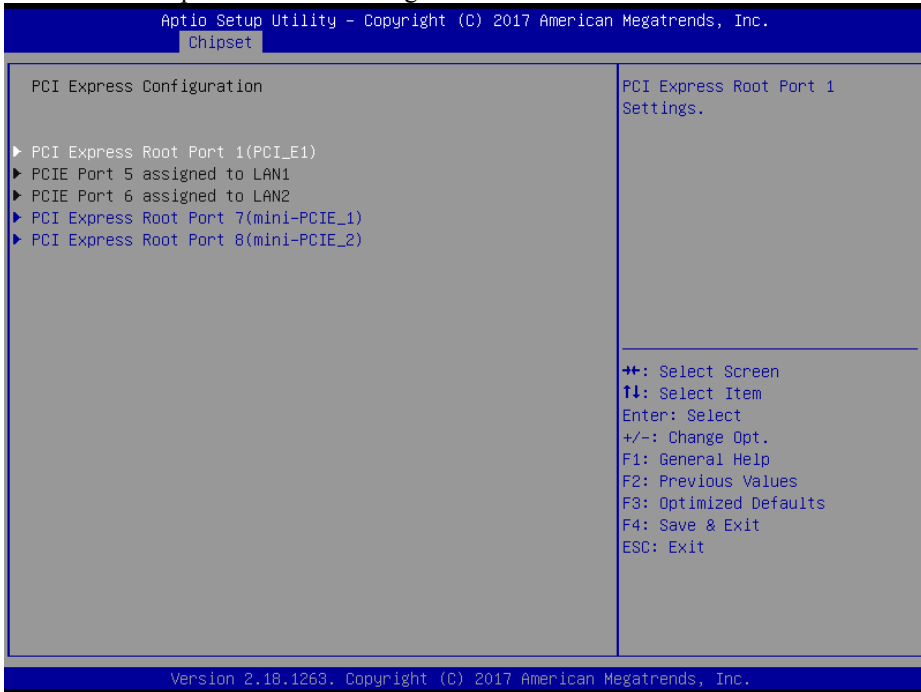

PCI Express Configuration Screen

BIOS Setting	Options	Description/Purpose
PCI Express Root Port 1 (PCI_E1)	Sub-menu	Allows users to configure PCI Express Root Port 1 settings.
PCI Express Root Port 5 assigned to LAN1	No changeable options	Assigns LAN1 to PCI Express Port 5.
PCI Express Root Port 6 assigned to LAN2	No changeable options	Assigns LAN2 to PCI Express Port 6.
PCI Express Root Port 7 (mini-PCIE_1)	Sub-menu	Allows users to configure Mini PCI Express Port 1 settings.
PCI Express Root Port 8 (mini-PCIE_2)	Sub-menu	Allows users to configure Mini PCI Express Port 2 settings.

Menu Path *Chipset > PCH-IO Configuration > PCI Express Configuration > PCI Express Root Port 1 (PCI_E1)*

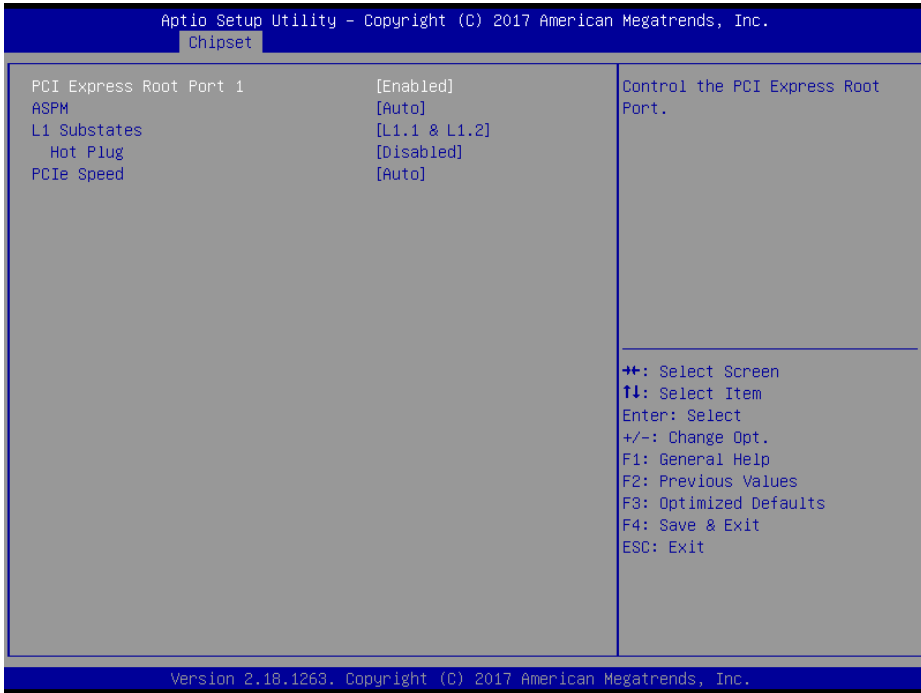

PCI Express Root Port 1 (PCI_E1) Configuration Screen

BIOS Setting	Options	Description/Purpose
PCI Express Root Port 1	- Disabled - Enabled	Controls the PCI Express Root Port.
ASPM	- Disabled - L0s - L1 - L0sL1 - Auto	Sets the PCI Express ASPM (Active-State Power Management) Level. The option allows users to set the lower power mode that activates when the bus is not being used.
L1 Substates	- Disabled - L1.1 - L1.2 - L1.1 & L1.2	PCI Express L1 Substates settings.
Hot Plug	- Disabled - Enabled	Enables or Disables PCI Express Hot Plug.
PCIe Speed	- Auto - Gen1 - Gen2 - Gen3	Selects PCI Express Port Speed.

Menu Path *Chipset > PCH-IO Configuration > PCI Express Configuration > PCI Express Root Port 7 (mini-PCIE_1)*

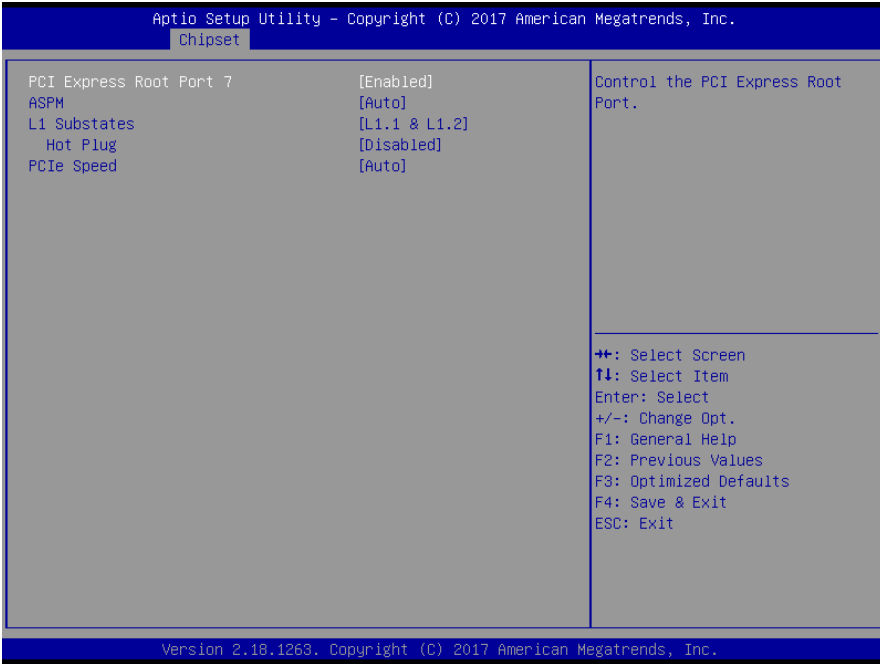

PCI Express Root Port 7 (mini-PCIE_1) Configuration Screen

BIOS Setting	Options	Description/Purpose
PCI Express Root Port 7	- Disabled - Enabled	Controls the PCI Express Root Port.
ASPM	- Disabled - L0s - L1 - L0sL1 - Auto	Sets the ASPM level.
L1 Substates	- Disabled - L1.1 - L1.2 - L1.1 & L1.2	PCI Express L1 Substates settings.
Hot Plug	- Disabled - Enabled	Enables or Disables PCI Express Hot Plug.
PCIe Speed	- Auto - Gen1 - Gen2 - Gen3	Selects PCI Express Port speed.

Menu Path *Chipset > PCH-IO Configuration > PCI Express Configuration > PCI Express Root Port 8 (mini-PCIE_2)*

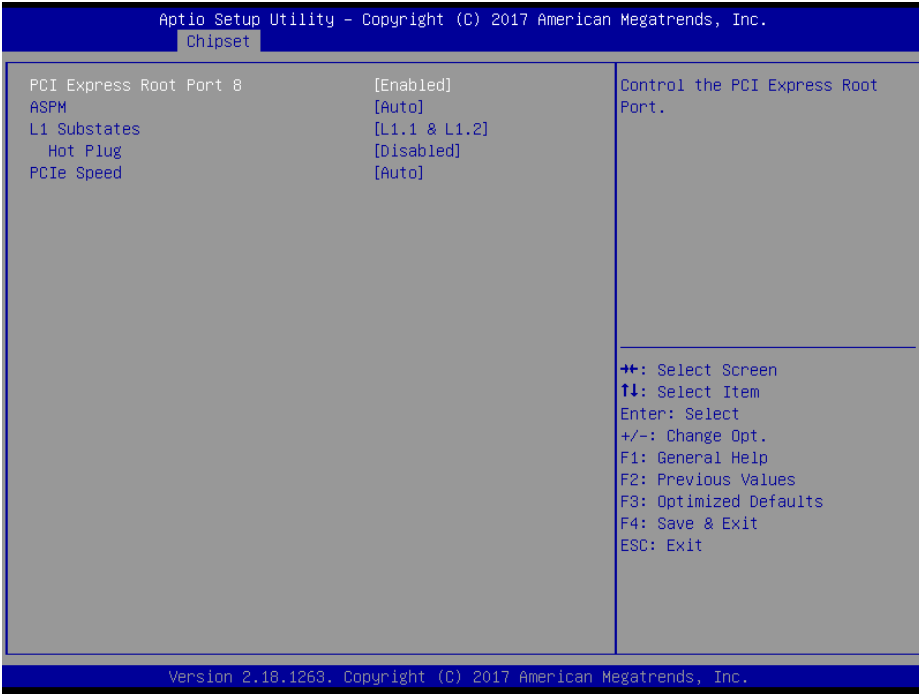

PCI Express Root Port 8 (mini-PCIE_2) Configuration Screen

BIOS Setting	Options	Description/Purpose
PCI Express Root Port 8	- Disabled - Enabled	Controls the PCI Express Root Port.
ASPM	- Disabled - L0s - L1 - L0sL1 - Auto	Sets the ASPM level.
L1 Substates	- Disabled - L1.1 - L1.2 - L1.1 & L1.2	PCI Express L1 Substates settings.
Hot Plug	- Disabled - Enabled	Enables or Disables PCI Express Hot Plug.
PCIe Speed	- Auto - Gen1 - Gen2 - Gen3	Selects PCI Express Port speed.

5.6 Security

Menu Path *Security*

From the **Security** menu, you are allowed to create, change or clear the administrator password. You will be asked to enter the configured administrator password before you can access the Setup Utility.

By setting an administrator password, you will prevent other users from changing your BIOS settings. You can configure an Administrator password and then configure a user password. An administrator has much more privileges over the settings in the Setup utility than a user. Heed that a user password does not provide access to most of the features in the Setup utility.

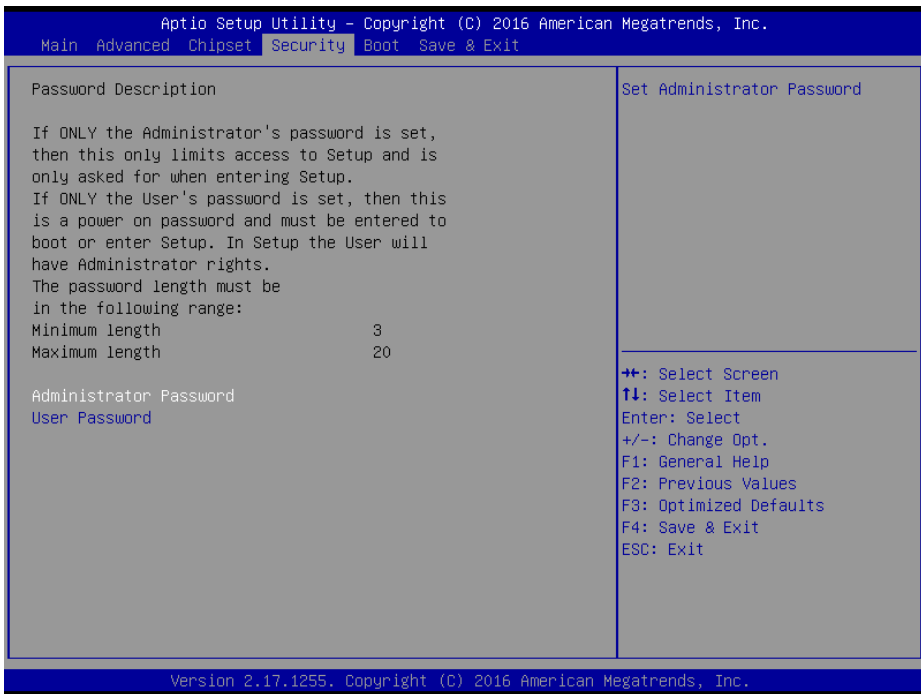

Security Screen

BIOS Setting	Options	Description/Purpose
Administrator Password	Password can be 3-20 alphanumeric characters.	Specifies the administrator password.
User Password	Password can be 3-20 alphanumeric characters.	Specifies the user password.

Create an Administrator or User Password

1. Select the **Administrator Password / User Password** option from the Security menu and press <Enter>, and the password dialog entry box appears.
2. Enter the password you want to create. A password can be 3-20 alphanumeric characters. After you have configured the password, press <Enter> to confirm.
3. Type the new password again and press <Enter>.

Change an Administrator or User Password

1. Select the **Administrator Password / User Password** option from the Security menu and press <Enter>, and the password dialog entry box appears.
2. Select the Administrator Password or User Password that you want to change. A password can be 3-20 alphanumeric characters. After you have changed the password, press <Enter> to confirm.
3. Type the changed password again and press <Enter>.

Remove an Administrator or User Password

1. Select the **Administrator Password / User Password** option from the Security menu and press <Enter>, and the password dialog entry box appears.
2. Select the configured Administrator Password or User Password that you want to delete. Leave the dialog box blank and press <Enter>.
3. Press <Enter> again when the password confirmation box appears.

5.7 Boot

Menu Path Boot

This menu provides control items for system boot configuration such as setting setup prompt timeout, enabling/disabling quiet boot and fast boot, changing the boot order from the available bootable device(s) and BBS (BIOS Boot Specification) option priorities, and setting CSM (Compatibility Support Module) configuration parameters to support legacy BIOS operation systems, various bootable devices and add-on devices for achieving better compatibility.

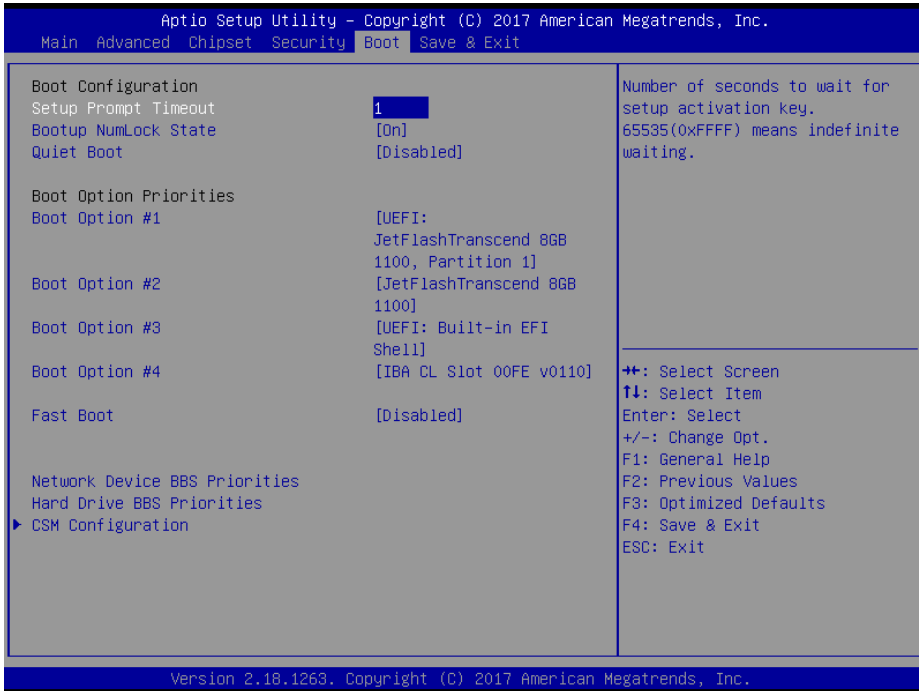

Boot Screen

BIOS Setting	Options	Description/Purpose
Setup Prompt Timeout	Numeric (from 1 to 65535)	Number of seconds to wait for setup activation key.
Bootup NumLock State	- On - Off	Selects the NumLock state after the system is powered on. <ul style="list-style-type: none"> • On: Enables the NumLock function automatically after the system is powered on. • Off: Disables the NumLock function after the system is powered on.

BIOS Setting	Options	Description/Purpose
Quiet Boot	- Disabled - Enabled	Enables or Disables Quiet Boot options. When this option is set to “Disabled”, BIOS will display normal POST messages.
Boot Option #1~#n	- [Drive(s)] - Disabled	Allows users to change the boot order from the available device(s). Note that in the menu displayed, you will only see the device with the highest priority for a specific boot device type.
Fast Boot	- Disabled - Enabled	Enables or Disables Fast Boot options.
Network Device BBS Priorities	Sub-Menu	Allows users to select the boot order of available device(s)
Hard Drive BBS Priorities	Sub-Menu	Defines the boot order for all the hard drives connected to the system, e.g. SATA, USB drive.
CSM Configuration	Sub-Menu	CSM configuration: Enable/Disable, Option ROM execution settings, etc.

5.7.1 Boot – Network Device BBS Priorities

Menu Path *Boot > Network Device BBS Priorities*

Select **Network Device BBS Priorities** from the **Boot** menu to configure the boot order and priority for devices that support Boot from LAN function.

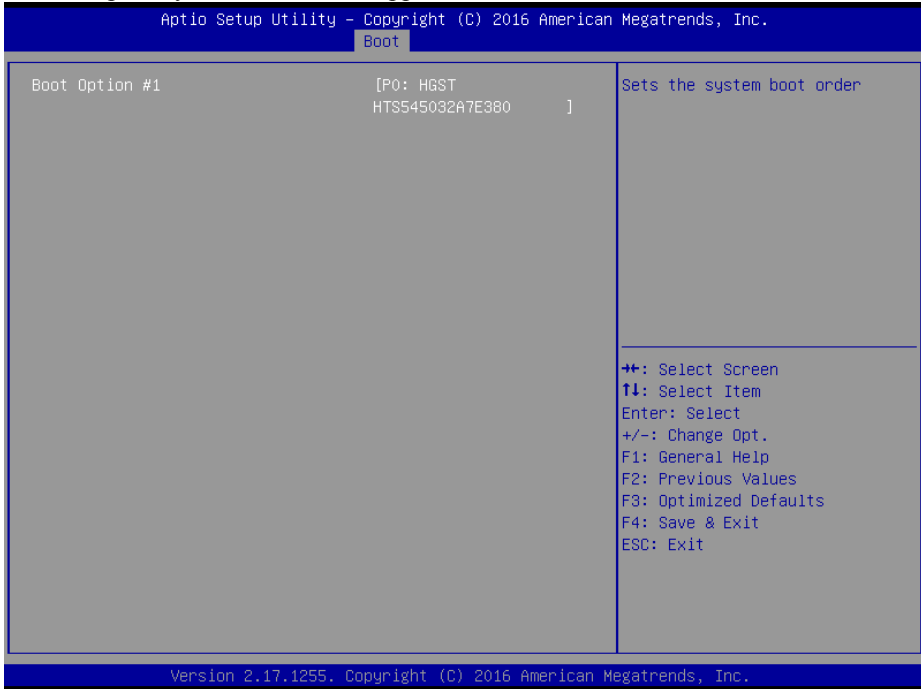

Network Device BBS Priorities Screen

BIOS Setting	Options	Description/Purpose
Boot Option #1~#n	- [Device(s)] - Enabled	Sets the system boot order for devices that support Boot from LAN function.

5.7.2 Boot – Hard Drive BBS Priorities

Menu Path *Boot > Hard Drive BBS Priorities*

Select **Hard Drive BBS Priorities** from the **Boot** menu to configure the boot order and priority of the available hard drives.

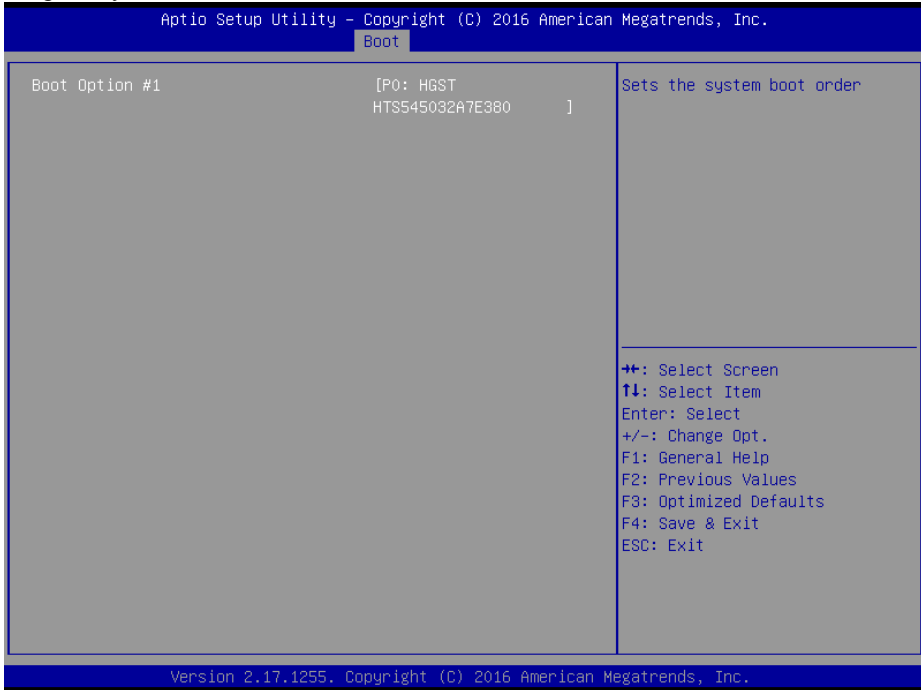

Hard Drive BBS Priorities Screen

BIOS Setting	Options	Description/Purpose
Boot Option #1~#n	- [Drive(s)] - Enabled	Set the system boot order for hard drives. Press Enter to enter the sub-menu and press <↑> or <↓> arrow keys to select the device. Another way is to press <+> or <-> to move the selected device up/down in the priority list.

5.7.3 Boot – CSM Configuration

Menu Path *Boot > CSM Configuration*

The **CSM Configuration** provides advanced CSM (Compatibility Support Module) configurations such as Enable/Disable CSM Support, configure Option ROM execution, boot option filter, etc.

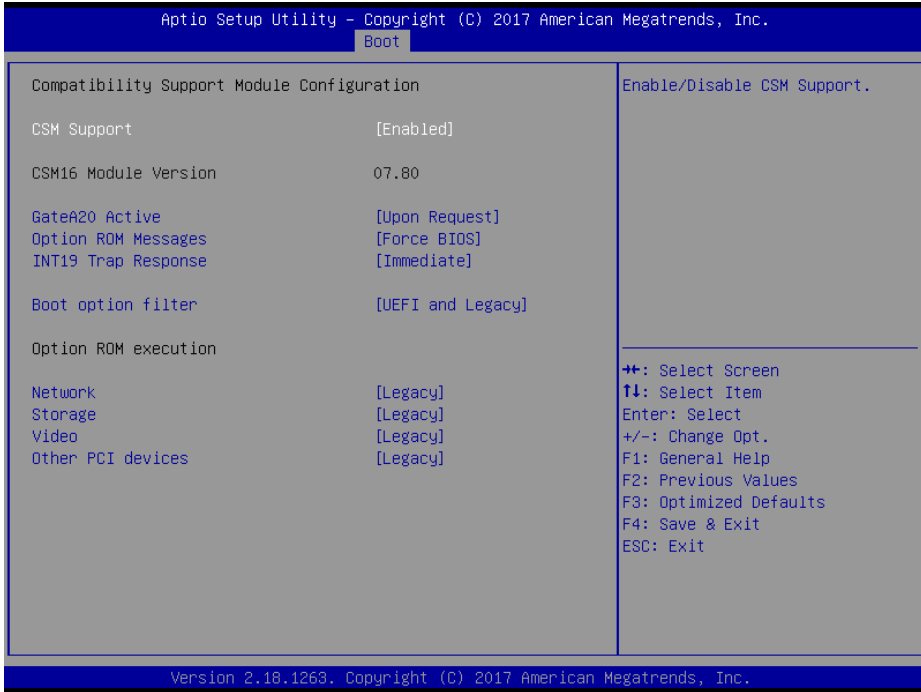

CSM Configuration Screen

BIOS Setting	Options	Description/Purpose
CSM Support	- Disabled - Enabled	Enables or Disables CSM Support.
CSM16 Module Version	No changeable options	Displays the CSM 16 Module version.
GateA20 Active	-Upon Request -Always	Upon Request: GA20 can be disabled using BIOS services. Always: This option is useful when any RT code is executed above 1MB.
Option ROM Messages	-Force BIOS -Keep Current	Sets display mode for Option ROM.

BIOS Setting	Options	Description/Purpose
INT19 Trap Response	<ul style="list-style-type: none">- Immediate- Postponed	Immediate: execute the trap right away. Postponed: execute the trap during legacy boot.
Boot option filter	<ul style="list-style-type: none">- UEFI and Legacy- Legacy only- UEFI only	This option controls Legacy/UEFI ROMs priority.
Network	<ul style="list-style-type: none">- Do not launch- UEFI- Legacy	Controls the execution of UEFI and Legacy PXE OpROM.
Storage	<ul style="list-style-type: none">- Do not launch- UEFI- Legacy	Controls the execution of UEFI and Legacy Storage OpROM.
Video	<ul style="list-style-type: none">- Do not launch- UEFI- Legacy	Controls the execution of UEFI and Legacy Video OpROM.
Other PCI devices	<ul style="list-style-type: none">- Do not launch- UEFI- Legacy	Determines OpROM execution policy for devices other than Network, Storage or Video.

5.8 Save & Exit

Menu Path *Save & Exit*

The **Save & Exit** allows users to save or discard changed BIOS settings as well as load factory default settings.

Save Changed BIOS Settings

To save and validate the changed BIOS settings, select **Save Changes** from the **Save & Exit** menu, or you can select **Save Changes and Exit** (or press **F4**) to validate the changes and then exit the system. Select **Save Changes and Reset** to validate the changed BIOS settings and then restart the system

Discard Changed BIOS Settings

To cancel the BIOS settings you have previously configured, select **Discard Changes and Exit** from this menu, or simply press **Esc** to exit the BIOS setup. You can also select **Discard Changes and Reset** to discard any changes you have made and restore the factory BIOS defaults.

Restore Defaults

You may simply press **F3** at any time to load the optimized values which resets all BIOS settings to the factory defaults.

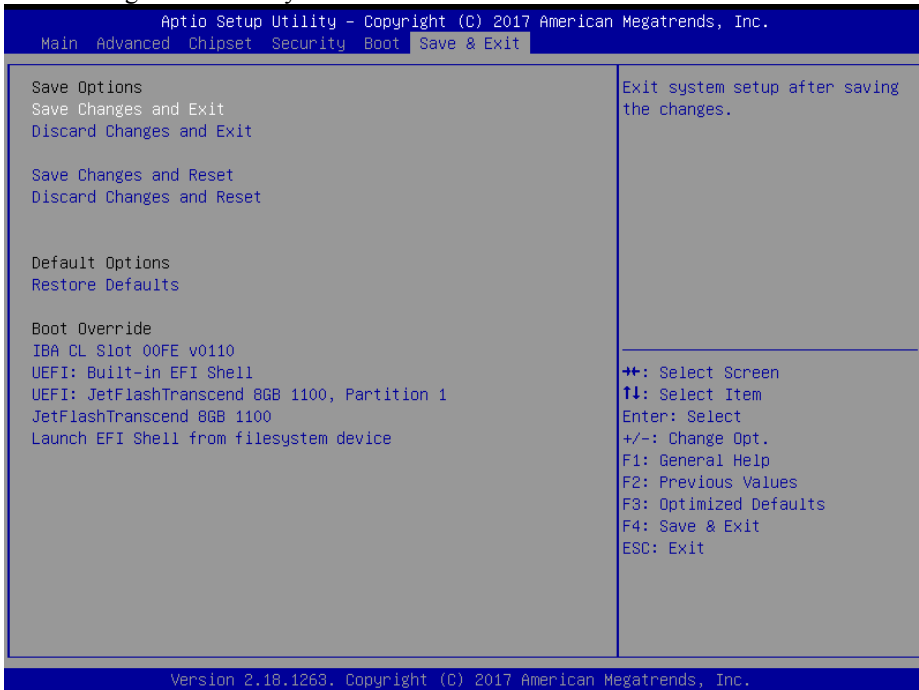

Save & Exit Screen

BIOS Setting	Options	Description/Purpose
Save Changes and Exit	No changeable options	Exits the system and saves the changes in NVRAM.
Discard Changes and Exit	No changeable options	Exits the system without saving any changes configured in BIOS settings.
Save Changes and Reset	No changeable options	Saves the changes in NVRAM and resets the system.
Discard Changes and Reset	No changeable options	Resets the system without saving any changes configured in BIOS settings.
Restore Defaults	No changeable options	Loads the optimized defaults for BIOS settings.
Boot Override	- [Drive(s)]	Forces to boot the system from selected [drive(s)].

Appendix A System Diagrams

This appendix includes the exploded diagrams of the system and the parts list as well as the part numbers of the EL1092 system.

- EL1092 System Exploded Diagram

System Exploded Diagram

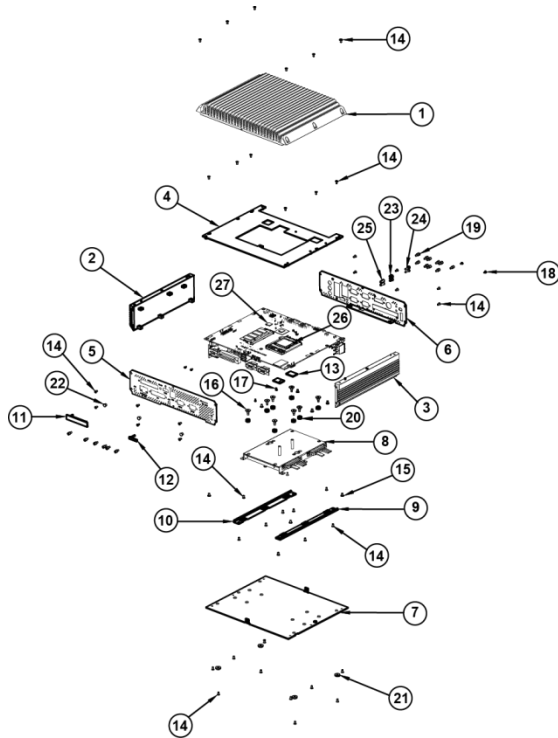

No.	Component Name	Part No.	Q'ty
Metal (AL Extrude)			
1	Heatsink top cover assy (259.63x200x33mm)	81-002-06000001	1
2	Heatsink right cover (200x57.8x12mm)	81-002-10058001	1
3	Heatsink left cover (200x57.8x12mm)	81-002-10058002	1
Metal (Bracket)			
4	PCB bracket	20-006-03004402	1
5	Rear I/O bracket (w/Paint)(Pantone 2188C)	20-006-03064402	1
6	Front I/O bracket (w/Paint)(Pantone 2188C)	20-006-03062402	1
7	Bottom bracket (w/Paint)(Black)	20-006-03061402	1
8	Double HDD bracket	20-006-03001402	1
9	HDD Link R Bracket	20-006-03003402	1
10	HDD Link L Bracket	20-006-03002402	1

Appendix A System Diagrams

No.	Component Name	Part No.	Q'ty
Rubber			
11	CFast rubber cover	30-013-01100261	1
12	SIM Card rubber cover	30-013-01200261	1
13	CPU rubber (20x15x2mm)	30-013-01100402	2
Screw / Other Component			
14	FLAT HEAD SCREW #2 / ϕ 5 / M3x0.5Px6mm (Black)	22-215-30006311	44
15	FILLISTER HEAD SCREW #2/M3x0.5Px6mm	82-275-30006018	8
16	FILLISTER HEAD SCREW M3x0.5Px4.8mm	82-272-30005013	8
17	ROUND WASHER HEAD SCREW #1/M2x0.4Px4mm	22-232-20004311	2
18	PAN HEAD SCREW M2.0x0.4Px6mm	22-222-20060011	4
19	HEX CU BOSS UNC No.4-40, L=4.8, H=7mm	22-692-40048051	16
20	RUBBER WASHER (OD= ϕ 9.62mm, ID= ϕ 3.9mmx5.8T) (Blue)	23-680-39580963	8
21	Rubber Foot (Φ 11.1x3.96mm)(Black)	90-004-01400000	4
22	HOLE PLUG (ϕ 6.3~6.5mm) (Black)	30-054-04100000	3
23	LED HOUSING (Black)	30-014-04100165	2
24	HOLE PLUG (Φ 4.7~4.9mm) (Black)	90-067-04400000	2
26	Thermal Interface Pads, 27.8x27.8x1mm (Light Gray)	21-006-82828001	1
27	Thermal Interface Pads, 10x10x1.0mm	81-006-81010003	2

Appendix B Technical Summary

This appendix will give you a brief introduction of the allocation maps for the system resources.

The following topics are included:

- Interrupt Map
- I/O Map
- Memory Map
- Configuring WatchDog Timer
- Flash BIOS Update

Interrupt Map

IRQ	Assignment
(ISA) IRQ 0	System timer
(ISA) IRQ 1	Standard PS/2 Keyboard
(ISA) IRQ 3	Communications Port (COM2)
(ISA) IRQ 4	Communications Port (COM1)
(ISA) IRQ 7	Communications Port (COM3)
(ISA) IRQ 7	Communications Port (COM4)
(ISA) IRQ 7	Communications Port (COM5)
(ISA) IRQ 7	Communications Port (COM6)
(ISA) IRQ 8	System CMOS/real time clock
(ISA) IRQ 11	Intel(R) HD Graphics 530
(ISA) IRQ 12	Microsoft PS/2 Mouse
(ISA) IRQ 13	Numeric data processor
(ISA) IRQ 14	Motherboard resources
(ISA) IRQ 54	Microsoft ACPI-Compliant System
(ISA) IRQ 55	Microsoft ACPI-Compliant System
(ISA) IRQ 56	Microsoft ACPI-Compliant System
(ISA) IRQ 57	Microsoft ACPI-Compliant System
(ISA) IRQ 58	Microsoft ACPI-Compliant System
(ISA) IRQ 59	Microsoft ACPI-Compliant System
(ISA) IRQ 60	Microsoft ACPI-Compliant System
(ISA) IRQ 61	Microsoft ACPI-Compliant System
(ISA) IRQ 62	Microsoft ACPI-Compliant System
(ISA) IRQ 63	Microsoft ACPI-Compliant System
(ISA) IRQ 64	Microsoft ACPI-Compliant System
(ISA) IRQ 65	Microsoft ACPI-Compliant System
(ISA) IRQ 66	Microsoft ACPI-Compliant System

IRQ	Assignment
(ISA) IRQ 67	Microsoft ACPI-Compliant System
(ISA) IRQ 68	Microsoft ACPI-Compliant System
(ISA) IRQ 69	Microsoft ACPI-Compliant System
(ISA) IRQ70	Microsoft ACPI-Compliant System
(ISA) IRQ 71	Microsoft ACPI-Compliant System
(ISA) IRQ 72	Microsoft ACPI-Compliant System
(ISA) IRQ 73	Microsoft ACPI-Compliant System
(ISA) IRQ 74	Microsoft ACPI-Compliant System
(ISA) IRQ 75	Microsoft ACPI-Compliant System
(ISA) IRQ 76	Microsoft ACPI-Compliant System
(ISA) IRQ 77	Microsoft ACPI-Compliant System
(ISA) IRQ 78	Microsoft ACPI-Compliant System
(ISA) IRQ 79	Microsoft ACPI-Compliant System
(ISA) IRQ 80	Microsoft ACPI-Compliant System
(ISA) IRQ 81	Microsoft ACPI-Compliant System
(ISA) IRQ 82	Microsoft ACPI-Compliant System
(ISA) IRQ 83	Microsoft ACPI-Compliant System
(ISA) IRQ 84	Microsoft ACPI-Compliant System
(ISA) IRQ 85	Microsoft ACPI-Compliant System
(ISA) IRQ 86	Microsoft ACPI-Compliant System
(ISA) IRQ 87	Microsoft ACPI-Compliant System
(ISA) IRQ 88	Microsoft ACPI-Compliant System
(ISA) IRQ 89	Microsoft ACPI-Compliant System
(ISA) IRQ 90	Microsoft ACPI-Compliant System
(ISA) IRQ 91	Microsoft ACPI-Compliant System
(ISA) IRQ 92	Microsoft ACPI-Compliant System
(ISA) IRQ 93	Microsoft ACPI-Compliant System

IRQ	Assignment
(ISA) IRQ 94	Microsoft ACPI-Compliant System
(ISA) IRQ 95	Microsoft ACPI-Compliant System
(ISA) IRQ 96	Microsoft ACPI-Compliant System
(ISA) IRQ 97	Microsoft ACPI-Compliant System
(ISA) IRQ 98	Microsoft ACPI-Compliant System
(ISA) IRQ 99	Microsoft ACPI-Compliant System
(ISA) IRQ 100	Microsoft ACPI-Compliant System
(ISA) IRQ 101	Microsoft ACPI-Compliant System
(ISA) IRQ 102	Microsoft ACPI-Compliant System
(ISA) IRQ 103	Microsoft ACPI-Compliant System
(ISA) IRQ 104	Microsoft ACPI-Compliant System
(ISA) IRQ 105	Microsoft ACPI-Compliant System
(ISA) IRQ 106	Microsoft ACPI-Compliant System
(ISA) IRQ 107	Microsoft ACPI-Compliant System
(ISA) IRQ 108	Microsoft ACPI-Compliant System
(ISA) IRQ 109	Microsoft ACPI-Compliant System
(ISA) IRQ 110	Microsoft ACPI-Compliant System
(ISA) IRQ 111	Microsoft ACPI-Compliant System
(ISA) IRQ 112	Microsoft ACPI-Compliant System
(ISA) IRQ 113	Microsoft ACPI-Compliant System
(ISA) IRQ 114	Microsoft ACPI-Compliant System
(ISA) IRQ 115	Microsoft ACPI-Compliant System
(ISA) IRQ 116	Microsoft ACPI-Compliant System
(ISA) IRQ 117	Microsoft ACPI-Compliant System
(ISA) IRQ 118	Microsoft ACPI-Compliant System
(ISA) IRQ 119	Microsoft ACPI-Compliant System
(ISA) IRQ 120	Microsoft ACPI-Compliant System

IRQ	Assignment
(ISA) IRQ 121	Microsoft ACPI-Compliant System
(ISA) IRQ 122	Microsoft ACPI-Compliant System
(ISA) IRQ 123	Microsoft ACPI-Compliant System
(ISA) IRQ 124	Microsoft ACPI-Compliant System
(ISA) IRQ 125	Microsoft ACPI-Compliant System
(ISA) IRQ 126	Microsoft ACPI-Compliant System
(ISA) IRQ 127	Microsoft ACPI-Compliant System
(ISA) IRQ 128	Microsoft ACPI-Compliant System
(ISA) IRQ 129	Microsoft ACPI-Compliant System
(ISA) IRQ 130	Microsoft ACPI-Compliant System
(ISA) IRQ 131	Microsoft ACPI-Compliant System
(ISA) IRQ 132	Microsoft ACPI-Compliant System
(ISA) IRQ 133	Microsoft ACPI-Compliant System
(ISA) IRQ 134	Microsoft ACPI-Compliant System
(ISA) IRQ 135	Microsoft ACPI-Compliant System
(ISA) IRQ 136	Microsoft ACPI-Compliant System
(ISA) IRQ 137	Microsoft ACPI-Compliant System
(ISA) IRQ 138	Microsoft ACPI-Compliant System
(ISA) IRQ 139	Microsoft ACPI-Compliant System
(ISA) IRQ 140	Microsoft ACPI-Compliant System
(ISA) IRQ 141	Microsoft ACPI-Compliant System
(ISA) IRQ 142	Microsoft ACPI-Compliant System
(ISA) IRQ 143	Microsoft ACPI-Compliant System
(ISA) IRQ 144	Microsoft ACPI-Compliant System
(ISA) IRQ 145	Microsoft ACPI-Compliant System
(ISA) IRQ 146	Microsoft ACPI-Compliant System
(ISA) IRQ 147	Microsoft ACPI-Compliant System

IRQ	Assignment
(ISA) IRQ 148	Microsoft ACPI-Compliant System
(ISA) IRQ 149	Microsoft ACPI-Compliant System
(ISA) IRQ 150	Microsoft ACPI-Compliant System
(ISA) IRQ 151	Microsoft ACPI-Compliant System
(ISA) IRQ 152	Microsoft ACPI-Compliant System
(ISA) IRQ 153	Microsoft ACPI-Compliant System
(ISA) IRQ 154	Microsoft ACPI-Compliant System
(ISA) IRQ 155	Microsoft ACPI-Compliant System
(ISA) IRQ 156	Microsoft ACPI-Compliant System
(ISA) IRQ 157	Microsoft ACPI-Compliant System
(ISA) IRQ 158	Microsoft ACPI-Compliant System
(ISA) IRQ 159	Microsoft ACPI-Compliant System
(ISA) IRQ 160	Microsoft ACPI-Compliant System
(ISA) IRQ 161	Microsoft ACPI-Compliant System
(ISA) IRQ 162	Microsoft ACPI-Compliant System
(ISA) IRQ 163	Microsoft ACPI-Compliant System
(ISA) IRQ 164	Microsoft ACPI-Compliant System
(ISA) IRQ 165	Microsoft ACPI-Compliant System
(ISA) IRQ 166	Microsoft ACPI-Compliant System
(ISA) IRQ 167	Microsoft ACPI-Compliant System
(ISA) IRQ 168	Microsoft ACPI-Compliant System
(ISA) IRQ 169	Microsoft ACPI-Compliant System
(ISA) IRQ 170	Microsoft ACPI-Compliant System
(ISA) IRQ 171	Microsoft ACPI-Compliant System
(ISA) IRQ 172	Microsoft ACPI-Compliant System
(ISA) IRQ 173	Microsoft ACPI-Compliant System
(ISA) IRQ 174	Microsoft ACPI-Compliant System

IRQ	Assignment
(ISA) IRQ 175	Microsoft ACPI-Compliant System
(ISA) IRQ 176	Microsoft ACPI-Compliant System
(ISA) IRQ 177	Microsoft ACPI-Compliant System
(ISA) IRQ 178	Microsoft ACPI-Compliant System
(ISA) IRQ 179	Microsoft ACPI-Compliant System
(ISA) IRQ 180	Microsoft ACPI-Compliant System
(ISA) IRQ 181	Microsoft ACPI-Compliant System
(ISA) IRQ 182	Microsoft ACPI-Compliant System
(ISA) IRQ 183	Microsoft ACPI-Compliant System
(ISA) IRQ 184	Microsoft ACPI-Compliant System
(ISA) IRQ 185	Microsoft ACPI-Compliant System
(ISA) IRQ 186	Microsoft ACPI-Compliant System
(ISA) IRQ 187	Microsoft ACPI-Compliant System
(ISA) IRQ 188	Microsoft ACPI-Compliant System
(ISA) IRQ 189	Microsoft ACPI-Compliant System
(ISA) IRQ 190	Microsoft ACPI-Compliant System
(ISA) IRQ 191	Microsoft ACPI-Compliant System
(ISA) IRQ 192	Microsoft ACPI-Compliant System
(ISA) IRQ 193	Microsoft ACPI-Compliant System
(ISA) IRQ 194	Microsoft ACPI-Compliant System
(ISA) IRQ 195	Microsoft ACPI-Compliant System
(ISA) IRQ 196	Microsoft ACPI-Compliant System
(ISA) IRQ 197	Microsoft ACPI-Compliant System
(ISA) IRQ 198	Microsoft ACPI-Compliant System
(ISA) IRQ 199	Microsoft ACPI-Compliant System
(ISA) IRQ 200	Microsoft ACPI-Compliant System
(ISA) IRQ 201	Microsoft ACPI-Compliant System

IRQ	Assignment
(ISA) IRQ 202	Microsoft ACPI-Compliant System
(ISA) IRQ 203	Microsoft ACPI-Compliant System
(ISA) IRQ 204	Microsoft ACPI-Compliant System
(ISA) IRQ 256	Microsoft ACPI-Compliant System
(ISA) IRQ 257	Microsoft ACPI-Compliant System
(ISA) IRQ 258	Microsoft ACPI-Compliant System
(ISA) IRQ 259	Microsoft ACPI-Compliant System
(ISA) IRQ 260	Microsoft ACPI-Compliant System
(ISA) IRQ 261	Microsoft ACPI-Compliant System
(ISA) IRQ 262	Microsoft ACPI-Compliant System
(ISA) IRQ 263	Microsoft ACPI-Compliant System
(ISA) IRQ 264	Microsoft ACPI-Compliant System
(ISA) IRQ 265	Microsoft ACPI-Compliant System
(ISA) IRQ 266	Microsoft ACPI-Compliant System
(ISA) IRQ 267	Microsoft ACPI-Compliant System
(ISA) IRQ 268	Microsoft ACPI-Compliant System
(ISA) IRQ 269	Microsoft ACPI-Compliant System
(ISA) IRQ 270	Microsoft ACPI-Compliant System
(ISA) IRQ 271	Microsoft ACPI-Compliant System
(ISA) IRQ 272	Microsoft ACPI-Compliant System
(ISA) IRQ 273	Microsoft ACPI-Compliant System
(ISA) IRQ 274	Microsoft ACPI-Compliant System
(ISA) IRQ 275	Microsoft ACPI-Compliant System
(ISA) IRQ 276	Microsoft ACPI-Compliant System
(ISA) IRQ 277	Microsoft ACPI-Compliant System
(ISA) IRQ 278	Microsoft ACPI-Compliant System
(ISA) IRQ 279	Microsoft ACPI-Compliant System

IRQ	Assignment
(ISA) IRQ 280	Microsoft ACPI-Compliant System
(ISA) IRQ 281	Microsoft ACPI-Compliant System
(ISA) IRQ 282	Microsoft ACPI-Compliant System
(ISA) IRQ 283	Microsoft ACPI-Compliant System
(ISA) IRQ 284	Microsoft ACPI-Compliant System
(ISA) IRQ 285	Microsoft ACPI-Compliant System
(ISA) IRQ 286	Microsoft ACPI-Compliant System
(ISA) IRQ 287	Microsoft ACPI-Compliant System
(ISA) IRQ 288	Microsoft ACPI-Compliant System
(ISA) IRQ 289	Microsoft ACPI-Compliant System
(ISA) IRQ 290	Microsoft ACPI-Compliant System
(ISA) IRQ 291	Microsoft ACPI-Compliant System
(ISA) IRQ 292	Microsoft ACPI-Compliant System
(ISA) IRQ 293	Microsoft ACPI-Compliant System
(ISA) IRQ 294	Microsoft ACPI-Compliant System
(ISA) IRQ 295	Microsoft ACPI-Compliant System
(ISA) IRQ 296	Microsoft ACPI-Compliant System
(ISA) IRQ 297	Microsoft ACPI-Compliant System
(ISA) IRQ 298	Microsoft ACPI-Compliant System
(ISA) IRQ 299	Microsoft ACPI-Compliant System
(ISA) IRQ 300	Microsoft ACPI-Compliant System
(ISA) IRQ 301	Microsoft ACPI-Compliant System
(ISA) IRQ 302	Microsoft ACPI-Compliant System
(ISA) IRQ 303	Microsoft ACPI-Compliant System
(ISA) IRQ 304	Microsoft ACPI-Compliant System
(ISA) IRQ 305	Microsoft ACPI-Compliant System
(ISA) IRQ 306	Microsoft ACPI-Compliant System

IRQ	Assignment
(ISA) IRQ 307	Microsoft ACPI-Compliant System
(ISA) IRQ 308	Microsoft ACPI-Compliant System
(ISA) IRQ 309	Microsoft ACPI-Compliant System
(ISA) IRQ 310	Microsoft ACPI-Compliant System
(ISA) IRQ 311	Microsoft ACPI-Compliant System
(ISA) IRQ 312	Microsoft ACPI-Compliant System
(ISA) IRQ 313	Microsoft ACPI-Compliant System
(ISA) IRQ 314	Microsoft ACPI-Compliant System
(ISA) IRQ 315	Microsoft ACPI-Compliant System
(ISA) IRQ 316	Microsoft ACPI-Compliant System
(ISA) IRQ 317	Microsoft ACPI-Compliant System
(ISA) IRQ 318	Microsoft ACPI-Compliant System
(ISA) IRQ 319	Microsoft ACPI-Compliant System
(ISA) IRQ 320	Microsoft ACPI-Compliant System
(ISA) IRQ 321	Microsoft ACPI-Compliant System
(ISA) IRQ 322	Microsoft ACPI-Compliant System
(ISA) IRQ 323	Microsoft ACPI-Compliant System
(ISA) IRQ 324	Microsoft ACPI-Compliant System
(ISA) IRQ 325	Microsoft ACPI-Compliant System
(ISA) IRQ 326	Microsoft ACPI-Compliant System
(ISA) IRQ 327	Microsoft ACPI-Compliant System
(ISA) IRQ 328	Microsoft ACPI-Compliant System
(ISA) IRQ 329	Microsoft ACPI-Compliant System
(ISA) IRQ 330	Microsoft ACPI-Compliant System
(ISA) IRQ 331	Microsoft ACPI-Compliant System
(ISA) IRQ 332	Microsoft ACPI-Compliant System
(ISA) IRQ 333	Microsoft ACPI-Compliant System

IRQ	Assignment
(ISA) IRQ 334	Microsoft ACPI-Compliant System
(ISA) IRQ 335	Microsoft ACPI-Compliant System
(ISA) IRQ 336	Microsoft ACPI-Compliant System
(ISA) IRQ 337	Microsoft ACPI-Compliant System
(ISA) IRQ 338	Microsoft ACPI-Compliant System
(ISA) IRQ 339	Microsoft ACPI-Compliant System
(ISA) IRQ 340	Microsoft ACPI-Compliant System
(ISA) IRQ 341	Microsoft ACPI-Compliant System
(ISA) IRQ 342	Microsoft ACPI-Compliant System
(ISA) IRQ 343	Microsoft ACPI-Compliant System
(ISA) IRQ 344	Microsoft ACPI-Compliant System
(ISA) IRQ 345	Microsoft ACPI-Compliant System
(ISA) IRQ 346	Microsoft ACPI-Compliant System
(ISA) IRQ 347	Microsoft ACPI-Compliant System
(ISA) IRQ 348	Microsoft ACPI-Compliant System
(ISA) IRQ 349	Microsoft ACPI-Compliant System
(ISA) IRQ 350	Microsoft ACPI-Compliant System
(ISA) IRQ 351	Microsoft ACPI-Compliant System
(ISA) IRQ 352	Microsoft ACPI-Compliant System
(ISA) IRQ 353	Microsoft ACPI-Compliant System
(ISA) IRQ 354	Microsoft ACPI-Compliant System
(ISA) IRQ 355	Microsoft ACPI-Compliant System
(ISA) IRQ 356	Microsoft ACPI-Compliant System
(ISA) IRQ 357	Microsoft ACPI-Compliant System
(ISA) IRQ 358	Microsoft ACPI-Compliant System
(ISA) IRQ 359	Microsoft ACPI-Compliant System
(ISA) IRQ 360	Microsoft ACPI-Compliant System

IRQ	Assignment
(ISA) IRQ 361	Microsoft ACPI-Compliant System
(ISA) IRQ 362	Microsoft ACPI-Compliant System
(ISA) IRQ 363	Microsoft ACPI-Compliant System
(ISA) IRQ 364	Microsoft ACPI-Compliant System
(ISA) IRQ 365	Microsoft ACPI-Compliant System
(ISA) IRQ 366	Microsoft ACPI-Compliant System
(ISA) IRQ 367	Microsoft ACPI-Compliant System
(ISA) IRQ 368	Microsoft ACPI-Compliant System
(ISA) IRQ 369	Microsoft ACPI-Compliant System
(ISA) IRQ 370	Microsoft ACPI-Compliant System
(ISA) IRQ 371	Microsoft ACPI-Compliant System
(ISA) IRQ 372	Microsoft ACPI-Compliant System
(ISA) IRQ 373	Microsoft ACPI-Compliant System
(ISA) IRQ 374	Microsoft ACPI-Compliant System
(ISA) IRQ 375	Microsoft ACPI-Compliant System
(ISA) IRQ 376	Microsoft ACPI-Compliant System
(ISA) IRQ 377	Microsoft ACPI-Compliant System
(ISA) IRQ 378	Microsoft ACPI-Compliant System
(ISA) IRQ 379	Microsoft ACPI-Compliant System
(ISA) IRQ 380	Microsoft ACPI-Compliant System
(ISA) IRQ 381	Microsoft ACPI-Compliant System
(ISA) IRQ 382	Microsoft ACPI-Compliant System
(ISA) IRQ 383	Microsoft ACPI-Compliant System
(ISA) IRQ 384	Microsoft ACPI-Compliant System
(ISA) IRQ 385	Microsoft ACPI-Compliant System
(ISA) IRQ 386	Microsoft ACPI-Compliant System
(ISA) IRQ 387	Microsoft ACPI-Compliant System

IRQ	Assignment
(ISA) IRQ 388	Microsoft ACPI-Compliant System
(ISA) IRQ 389	Microsoft ACPI-Compliant System
(ISA) IRQ 390	Microsoft ACPI-Compliant System
(ISA) IRQ 391	Microsoft ACPI-Compliant System
(ISA) IRQ 392	Microsoft ACPI-Compliant System
(ISA) IRQ 393	Microsoft ACPI-Compliant System
(ISA) IRQ 394	Microsoft ACPI-Compliant System
(ISA) IRQ 395	Microsoft ACPI-Compliant System
(ISA) IRQ 396	Microsoft ACPI-Compliant System
(ISA) IRQ 397	Microsoft ACPI-Compliant System
(ISA) IRQ 398	Microsoft ACPI-Compliant System
(ISA) IRQ 399	Microsoft ACPI-Compliant System
(ISA) IRQ 400	Microsoft ACPI-Compliant System
(ISA) IRQ 401	Microsoft ACPI-Compliant System
(ISA) IRQ 402	Microsoft ACPI-Compliant System
(ISA) IRQ 403	Microsoft ACPI-Compliant System
(ISA) IRQ 404	Microsoft ACPI-Compliant System
(ISA) IRQ 405	Microsoft ACPI-Compliant System
(ISA) IRQ 406	Microsoft ACPI-Compliant System
(ISA) IRQ 407	Microsoft ACPI-Compliant System
(ISA) IRQ 408	Microsoft ACPI-Compliant System
(ISA) IRQ 409	Microsoft ACPI-Compliant System
(ISA) IRQ 410	Microsoft ACPI-Compliant System
(ISA) IRQ 411	Microsoft ACPI-Compliant System
(ISA) IRQ 412	Microsoft ACPI-Compliant System
(ISA) IRQ 413	Microsoft ACPI-Compliant System
(ISA) IRQ 414	Microsoft ACPI-Compliant System

IRQ	Assignment
(ISA) IRQ 415	Microsoft ACPI-Compliant System
(ISA) IRQ 404	Microsoft ACPI-Compliant System
(ISA) IRQ 405	Microsoft ACPI-Compliant System
(ISA) IRQ 406	Microsoft ACPI-Compliant System
(ISA) IRQ 407	Microsoft ACPI-Compliant System
(ISA) IRQ 408	Microsoft ACPI-Compliant System
(ISA) IRQ 409	Microsoft ACPI-Compliant System
(ISA) IRQ 410	Microsoft ACPI-Compliant System
(ISA) IRQ 411	Microsoft ACPI-Compliant System
(ISA) IRQ 412	Microsoft ACPI-Compliant System
(ISA) IRQ 413	Microsoft ACPI-Compliant System
(ISA) IRQ 414	Microsoft ACPI-Compliant System
(ISA) IRQ 415	Microsoft ACPI-Compliant System
(ISA) IRQ 416	Microsoft ACPI-Compliant System
(ISA) IRQ 417	Microsoft ACPI-Compliant System
(ISA) IRQ 418	Microsoft ACPI-Compliant System
(ISA) IRQ 419	Microsoft ACPI-Compliant System
(ISA) IRQ 420	Microsoft ACPI-Compliant System
(ISA) IRQ 421	Microsoft ACPI-Compliant System
(ISA) IRQ 422	Microsoft ACPI-Compliant System
(ISA) IRQ 423	Microsoft ACPI-Compliant System
(ISA) IRQ 424	Microsoft ACPI-Compliant System
(ISA) IRQ 425	Microsoft ACPI-Compliant System
(ISA) IRQ 426	Microsoft ACPI-Compliant System
(ISA) IRQ 427	Microsoft ACPI-Compliant System
(ISA) IRQ 428	Microsoft ACPI-Compliant System
(ISA) IRQ 429	Microsoft ACPI-Compliant System

IRQ	Assignment
(ISA) IRQ 430	Microsoft ACPI-Compliant System
(ISA) IRQ 431	Microsoft ACPI-Compliant System
(ISA) IRQ 432	Microsoft ACPI-Compliant System
(ISA) IRQ 433	Microsoft ACPI-Compliant System
(ISA) IRQ 434	Microsoft ACPI-Compliant System
(ISA) IRQ 435	Microsoft ACPI-Compliant System
(ISA) IRQ 436	Microsoft ACPI-Compliant System
(ISA) IRQ 437	Microsoft ACPI-Compliant System
(ISA) IRQ 438	Microsoft ACPI-Compliant System
(ISA) IRQ 439	Microsoft ACPI-Compliant System
(ISA) IRQ 440	Microsoft ACPI-Compliant System
(ISA) IRQ 441	Microsoft ACPI-Compliant System
(ISA) IRQ 442	Microsoft ACPI-Compliant System
(ISA) IRQ 443	Microsoft ACPI-Compliant System
(ISA) IRQ 444	Microsoft ACPI-Compliant System
(ISA) IRQ 445	Microsoft ACPI-Compliant System
(ISA) IRQ 446	Microsoft ACPI-Compliant System
(ISA) IRQ 447	Microsoft ACPI-Compliant System
(ISA) IRQ 448	Microsoft ACPI-Compliant System
(ISA) IRQ 449	Microsoft ACPI-Compliant System
(ISA) IRQ 450	Microsoft ACPI-Compliant System
(ISA) IRQ 451	Microsoft ACPI-Compliant System
(ISA) IRQ 452	Microsoft ACPI-Compliant System
(ISA) IRQ 453	Microsoft ACPI-Compliant System
(ISA) IRQ 454	Microsoft ACPI-Compliant System
(ISA) IRQ 455	Microsoft ACPI-Compliant System
(ISA) IRQ 456	Microsoft ACPI-Compliant System

IRQ	Assignment
(ISA) IRQ 457	Microsoft ACPI-Compliant System
(ISA) IRQ 458	Microsoft ACPI-Compliant System
(ISA) IRQ 459	Microsoft ACPI-Compliant System
(ISA) IRQ 460	Microsoft ACPI-Compliant System
(ISA) IRQ 461	Microsoft ACPI-Compliant System
(ISA) IRQ 462	Microsoft ACPI-Compliant System
(ISA) IRQ 463	Microsoft ACPI-Compliant System
(ISA) IRQ 464	Microsoft ACPI-Compliant System
(ISA) IRQ 465	Microsoft ACPI-Compliant System
(ISA) IRQ 466	Microsoft ACPI-Compliant System
(ISA) IRQ 467	Microsoft ACPI-Compliant System
(ISA) IRQ 468	Microsoft ACPI-Compliant System
(ISA) IRQ 469	Microsoft ACPI-Compliant System
(ISA) IRQ 470	Microsoft ACPI-Compliant System
(ISA) IRQ 471	Microsoft ACPI-Compliant System
(ISA) IRQ 472	Microsoft ACPI-Compliant System
(ISA) IRQ 473	Microsoft ACPI-Compliant System
(ISA) IRQ 474	Microsoft ACPI-Compliant System
(ISA) IRQ 475	Microsoft ACPI-Compliant System
(ISA) IRQ 476	Microsoft ACPI-Compliant System
(ISA) IRQ 477	Microsoft ACPI-Compliant System
(ISA) IRQ 478	Microsoft ACPI-Compliant System
(ISA) IRQ 479	Microsoft ACPI-Compliant System
(ISA) IRQ 480	Microsoft ACPI-Compliant System
(ISA) IRQ 481	Microsoft ACPI-Compliant System
(ISA) IRQ 482	Microsoft ACPI-Compliant System
(ISA) IRQ 483	Microsoft ACPI-Compliant System

IRQ	Assignment
(ISA) IRQ 484	Microsoft ACPI-Compliant System
(ISA) IRQ 485	Microsoft ACPI-Compliant System
(ISA) IRQ 486	Microsoft ACPI-Compliant System
(ISA) IRQ 487	Microsoft ACPI-Compliant System
(ISA) IRQ 488	Microsoft ACPI-Compliant System
(ISA) IRQ 489	Microsoft ACPI-Compliant System
(ISA) IRQ 490	Microsoft ACPI-Compliant System
(ISA) IRQ 491	Microsoft ACPI-Compliant System
(ISA) IRQ 492	Microsoft ACPI-Compliant System
(ISA) IRQ 493	Microsoft ACPI-Compliant System
(ISA) IRQ 494	Microsoft ACPI-Compliant System
(ISA) IRQ 495	Microsoft ACPI-Compliant System
(ISA) IRQ 496	Microsoft ACPI-Compliant System
(ISA) IRQ 497	Microsoft ACPI-Compliant System
(ISA) IRQ 498	Microsoft ACPI-Compliant System
(ISA) IRQ 499	Microsoft ACPI-Compliant System
(ISA) IRQ 500	Microsoft ACPI-Compliant System
(ISA) IRQ 501	Microsoft ACPI-Compliant System
(ISA) IRQ 502	Microsoft ACPI-Compliant System
(ISA) IRQ 503	Microsoft ACPI-Compliant System
(ISA) IRQ 504	Microsoft ACPI-Compliant System
(ISA) IRQ 505	Microsoft ACPI-Compliant System
(ISA) IRQ 506	Microsoft ACPI-Compliant System
(ISA) IRQ 507	Microsoft ACPI-Compliant System
(ISA) IRQ 508	Microsoft ACPI-Compliant System
(ISA) IRQ 509	Microsoft ACPI-Compliant System
(ISA) IRQ 510	Microsoft ACPI-Compliant System

IRQ	Assignment
(ISA) IRQ 511	Microsoft ACPI-Compliant System
(PCI) IRQ 11	Intel(R) 100 Series/C230 Series Chipset Family Integrated Sensor Hub - A135
(PCI) IRQ 11	Intel(R) 100 Series/C230 Series Chipset Family Thermal subsystem - A31
(PCI) IRQ 11	Intel(R) 100 Series/C230 Series Chipset Family SMBus - A123
(PCI) IRQ 11	Intel(R) Xeon(R) E3 - 1200/1500 v5/6th Gen Intel(R) Core(TM) Gaussian Mixture Model - 1911
(PCI) IRQ 16	High Definition Audio Controller
(PCI) IRQ -12	Intel(R) Management Engine Interface
(PCI) IRQ -11	Intel(R) I210 Gigabit Network Connection
(PCI) IRQ -10	Intel(R) I210 Gigabit Network Connection
(PCI) IRQ -9	Intel(R) I210 Gigabit Network Connection
(PCI) IRQ -8	Intel(R) I210 Gigabit Network Connection
(PCI) IRQ -7	Intel(R) I210 Gigabit Network Connection
(PCI) IRQ -6	Intel(R) I210 Gigabit Network Connection
(PCI) IRQ -5	Intel(R) USB3.0 eXtensible Host Controller - 1.0 (Microsoft)
(PCI) IRQ -4	Intel(R) Ethernet Connection (2) I219-LM
(PCI) IRQ -3	Standard SATA AHCI Controller
(PCI) IRQ -2	Intel(R) 100 Series/C230 Series Chipset Family PCI Express Root Port #6 - A115

I/O Map

I/O Map	Assignment
0x00000000-0x00000CF7	PCI Express Root Complex
0x00000020-0x00000021	Programmable interrupt controller
0x00000024-0x00000025	Programmable interrupt controller
0x00000028-0x00000029	Programmable interrupt controller
0x0000002C-0x0000002D	Programmable interrupt controller
0x0000002E-0x0000002F	Motherboard resources
0x00000030-0x00000031	Programmable interrupt controller
0x00000034-0x00000035	Programmable interrupt controller
0x00000038-0x00000039	Programmable interrupt controller
0x0000003C-0x0000003D	Programmable interrupt controller
0x00000040-0x00000043	System timer
0x0000004E-0x0000004F	Motherboard resources
0x00000050-0x00000053	System timer
0x00000060-0x00000060	Standard PS/2 Keyboard
0x00000061-0x00000061	Motherboard resources
0x00000063-0x00000063	Motherboard resources
0x00000064-0x00000064	Standard PS/2 Keyboard
0x00000065-0x00000065	Motherboard resources
0x00000067-0x00000067	Motherboard resources
0x00000070-0x00000070	Motherboard resources
0x00000070-0x00000077	System CMOS/real time clock
0x00000080-0x00000080	Motherboard resources
0x00000092-0x00000092	Motherboard resources
0x000000A0-0x000000A1	Programmable interrupt controller
0x000000A4-0x000000A5	Programmable interrupt controller
0x000000A8-0x000000A9	Programmable interrupt controller

Memory Map

Memory Map	Assignment
0x000A0000-0x000BFFFF	Microsoft Basic Display Adapter
0x000A0000-0x000BFFFF	PCI Express Root Complex
0x90000000-0xDFFFFFFF	PCI Express Root Complex
0xC0000000-0xCFFFFFFF	Intel(R) HD Graphics 530
0xC0000000-0xCFFFFFFF	Microsoft Basic Display Adapter
0xDE000000-0xDEFFFFFF	Intel(R) HD Graphics 530
0xDE000000-0xDEFFFFFF	Microsoft Basic Display Adapter
0xDF000000-0xDF07FFFF	Intel(R) I210 Gigabit Network Connection
0xDF000000-0xDF0FFFFFF	Intel(R) 100 Series/C230 Series Chipset Family PCI Express Root Port #6 - A115
0xDF080000-0xDF083FFF	Intel(R) I210 Gigabit Network Connection
0xDF100000-0xDF11FFFF	Intel(R) Ethernet Connection (2) I219-LM
0xDF120000-0xDF12FFFF	High Definition Audio Controller
0xDF130000-0xDF13FFFF	Intel(R) USB 3.0 eXtensible Host Controller - 1.0 (Microsoft)
0xDF140000-0xDF143FFF	High Definition Audio Controller
0xDF144000-0xDF147FFF	Intel(R) 100 Series/C230 Series Chipset Family PMC - A121
0xDF148000-0xDF149FFF	Standard SATA AHCI Controller
0xDF14A000-0xDF14A0FF	Intel(R) 100 Series/C230 Series Chipset Family SMBus - A123
0xDF14B000-0xDF14B7FF	Standard SATA AHCI Controller
0xDF14C000-0xDF14C0FF	Standard SATA AHCI Controller
0xDF14E000-0xDF14EFFF	Intel(R) 100 Series/C230 Series Chipset Family Thermal subsystem - A31
0xDF14F000-0xDF14FFFF	Intel(R) 100 Series/C230 Series Chipset Family Integrated Sensor Hub - A135
0xDF150000-0xDF150FFF	Intel(R) Xeon(R) E3 - 1200/1500 v5/6th Gen Intel(R) Core(TM) Gaussian Mixture Model - 1911

Memory Map	Assignment
0xDFFE0000-0xDFFFFFFF	Motherboard resources
0xE0000000-0xEFFFFFFF	Motherboard resources
0xFD000000-0xFDABFFFF	Motherboard resources
0xFDAC0000-0xFDACFFFF	Motherboard resources
0xFDAD0000-0xFDADFFFF	Motherboard resources
0xFDAE0000-0xFDAEFFFF	Motherboard resources
0xFDAF0000-0xFDAFFFFFFF	Motherboard resources
0xFDB00000-0xFDFFFFFFF	Motherboard resources
0xFE000000-0xFE01FFFF	Motherboard resources
0xFE036000-0xFE03BFFF	Motherboard resources
0xFE03D000-0xFE3FFFFF	Motherboard resources
0xFE410000-0xFE7FFFFF	Motherboard resources
0xFED00000-0xFED003FF	High precision event timer
0xFED10000-0xFED17FFF	Motherboard resources
0xFED18000-0xFED18FFF	Motherboard resources
0xFED19000-0xFED19FFF	Motherboard resources
0xFED20000-0xFED3FFFF	Motherboard resources
0xFED45000-0xFED8FFFF	Motherboard resources
0xFED90000-0xFED93FFF	Motherboard resources
0xFEE00000-0xFEEFFFFFFF	Motherboard resources
0xFF000000-0xFFFFFFFF	Legacy device
0xFF000000-0xFFFFFFFF	Motherboard resources

Configuring WatchDog Timer

The I/O port address of the watchdog timer is 2E (hex) and 2F (hex). 2E (hex) is the address port. 2F (hex) is the data port. User must first assign the address of register by writing address value into address port 2E (hex), then write/read data to/from the assigned register through data port 2F (hex).

Configuration Sequence

To program F81866 configuration registers, the following configuration sequence must be followed:

(1) Enter the extended function mode

To place the chip into the Extended Function Mode, two successive writes of 0x87 must be applied to Extended Function Enable Registers (EFERs, i.e. 2Eh or 4Eh).

(2) Configure the configuration registers

The chip selects the Logical Device and activates the desired Logical Devices through Extended Function Index Register (EFIR) and Extended Function Data Register (EFDR). The EFIR is located at the same address as the EFER, and the EFDR is located at address (EFIR+1). First, write the Logical Device Number (i.e. 0x07) to the EFIR and then write the number of the desired Logical Device to the EFDR. If accessing the Chip (Global) Control Registers, this step is not required. Secondly, write the address of the desired configuration register within the Logical Device to the EFIR and then write (or read) the desired configuration register through the EFDR.

(3) Exit the extended function mode

To exit the Extended Function Mode, writing 0xAA to the EFER is required. Once the chip exits the Extended Function Mode, it is in the normal running mode and is ready to enter the configuration mode.

Code example for watch dog timer

```

;----- Enter to extended function mode -----
mov     dx,      2eh
mov     al,      87h
out     dx,      al
out     dx,      al
;----- Select Logical Device 7 of watchdog timer -----
mov     al, 07h
out     dx, al
inc     dx
mov     al, 07h
out     dx, al
;----- Enable Watch dog feature -----
mov     al,      030h
out     dx,      al
inc     dx
mov     al, 01h
out     dx,      al
;----- Enable Watch PME-----
dec     dx
mov     al, 0FAh
out     dx, al
inc     dx
in      al, dx
and     al, 51h
out     dx,      al
;----- Set second as counting unit -----
dec     dx
mov     al,      0f5h
out     dx, al
inc     dx
in      al,      dx
and     al,      30h
out     dx,      al
;----- Set timeout interval as 30seconds and start counting -----
dec     dx
mov     al,      0f6h
out     dx,      al
inc     dx
mov     al, 1Eh
out     dx,      al
;----- Exit the extended function mode -----
dec     dx
mov     al,      0aah
out     dx,      al

```

Flash BIOS Update

I. Prerequisites

- 1 Prepare a bootable media (e.g. USB storage device) which can boot the system to DOS prompt.
- 2 Download and save the BIOS file (e.g. 84001TQ1.bin) to the bootable device.
- 3 Copy AMI flash utility – AFUDOS.exe (v5.07.01) into the bootable device.
- 4 Make sure the target system can first boot to the bootable device.
 - (1) Connect the bootable USB device.
 - (2) Turn on the computer and press <ESC> or during boot to enter BIOS Setup.
 - (3) The system will go into the BIOS setup menu.
 - (4) Select **[Boot]** menu.
 - (5) Select **[Hard Drive BBS Priorities]** and set the USB bootable device as the 1st boot device.
 - (6) Press **F4** to save the configuration and exit the BIOS setup menu.



II. AFUDOS Command for System BIOS Update

AFUDOS.exe is the AMI firmware update utility; the command line is shown as below:

AFUDOS <ROM File Name> [option1] [option2]....

Users can type “AFUDOS/ ?” to see all the definition of each control options. The recommended options for BIOS ROM update include following parameters:

- /P:** Program main BIOS image.
- /B:** Program Boot Block.
- /N:** Program NVRAM.
- /X:** Don't check ROM ID.

III. BIOS Update Procedure

- 1** Use the bootable USB storage to boot up the system into the DOS command prompt.
- 2** Type "**AFUDOS 8400xxxx.bin /p /b /n /x**" and press **Enter** to start the flash procedure.
(Note that xxxx means the BIOS revision part, e.g. 0PD1...)
- 3** During the BIOS update procedure, you will see the BIOS update process status and its percentage. Beware! Do not turn off the system power or reset your computer when the entire update procedure are not complete; otherwise, the BIOS ROM may be crashed and the system will be unable to boot up next time.
- 4** After the BIOS update procedure is completed, the following messages will be shown:

```
C:\AMI\A5>afudos 84001TQ1.bin /b /n /p /x
+-----+
|           AMI Firmware Update Utility   v5.07.01           |
|   Copyright (C) 2014 AMI Megatrends Inc. All Right Reserved   |
+-----+
Reading flash . . . . . done
- ME Data Size Checking . ok
- FFS Checksums . . . . . ok
Erasing Boot Block . . . . . done
Updating Boot Block . . . . . done
Verifying Boot Block . . . . . done
Erasing Main Block . . . . . done
Updating Main Block . . . . . done
Verifying Main Block . . . . . done
Erasing NVRAM Block . . . . . done
Updating NVRAM Block . . . . . done
Verifying NVRAM Block . . . . . done

C:\AMI\A5>
```

- 5 Restart the system and boot up with the new BIOS configurations.
- 6 The BIOS Update is completed after the system is restarted.
- 7 Reboot the system and verify if the BIOS version shown on the initialization screen has been updated.

