

# M116K

---

## Windows Rugged Tablet

Intel® Core™ i5-7300U 2.60 GHz

Windows® 10 IoT Enterprise



# User Guide

---

# Contents

<b>CONTENTS</b>	<b>1</b>
<b>CHAPTER 1: READ ME FIRST</b>	<b>3</b>
1.1 ADVISORY CONVENTIONS	3
1.2 SAFETY INFORMATION	4
1.3 HANDLING AND MAINTENANCE	6
1.4 DECLARATION OF CONFORMITY (DOC)	7
<b>CHAPTER 2: GETTING STARTED</b>	<b>8</b>
2.1 INTRODUCTION	8
2.2 UNPACKING	9
2.3 DESCRIPTION OF PARTS	10
2.4 INDICATORS	12
2.5 HOTKEY FOR SPECIFIC FUNCTIONS	12
2.6 FIRST-TIME OPERATION	12
2.6.1 <i>Installing Battery</i>	12
2.6.2 <i>Installing a Micro SD Card</i>	13
2.6.3 <i>Installing 4G LTE Module</i>	14
2.6.4 <i>Installing SIM card (For 4G/LTE Equipped Devices)</i>	15
2.6.5 <i>Charging Your Tablet</i>	16
2.6.6 <i>Using LAN Port (RJ45)</i>	17
2.6.7 <i>Starting the Tablet</i>	17
<b>CHAPTER 3: SETTING UP WINDOWS FOR THE FIRST TIME</b>	<b>18</b>
3.1 INTRODUCTION	18
3.2 SETTING UP WINDOWS 10 IOT ENTERPRISE	18
<b>CHAPTER 4: OPERATING THE DEVICE</b>	<b>21</b>
4.1 HOTTAB INTRODUCTION	21
4.2 SHORTCUTS	22
4.3 USING CAMERA	23
4.4 ADJUSTING LED BRIGHTNESS	24
4.5 BUILT-IN DEVICES ON/OFF	28
4.5.1 <i>Using the Wireless LAN (Wi-Fi)</i>	28
4.5.2 <i>Using the Wireless WAN (4G LTE)</i>	28
4.5.3 <i>Using the GPS</i>	29
4.5.4 <i>Turn on/off the GPS External Antenna</i>	29
4.5.5 <i>Using the Bluetooth</i>	30
4.5.6 <i>Turning On/Off LED Indicators</i>	30
4.5.7 <i>Using the Barcode Reader</i>	31
4.5.8 <i>Using the HF RFID Reader</i>	39
4.5.9 <i>Turn on/off the Light Sensor</i>	43
4.5.10 <i>Changing Touchscreen Modes</i>	44
<b>CHAPTER 5: FREQUENTLY USED SETTINGS</b>	<b>47</b>
5.1 SCREEN RESOLUTION SCALING AND SETTING	47
5.1.1 <i>Changing Display Scaling (Recommended)</i>	47
5.1.2 <i>Changing Screen Resolution</i>	48
5.2 REPLACING BATTERY	49
5.3 USING RECOVERY WIZARD TO RESTORE COMPUTER	50
5.4 DOCKING CONNECTOR PIN DEFINITION	52
5.5 COM PORT DEFINITION	52
5.6 GIGALAN PORT DEFINITION	54
5.7 PAIRING WITH A WIRELESS BLUETOOTH BARCODE SCANNER	54
5.7.1 <i>Setup Computer for Bluetooth Pairing</i>	54
5.7.2 <i>Set up the Barcode Scanner for Bluetooth Pairing</i>	57
5.7.3 <i>Perform Bluetooth Pairing</i>	57

<b>CHAPTER 6: TROUBLESHOOTING</b>	<b>59</b>
6.1 BASIC TROUBLESHOOTING	59
<b>APPENDIX</b>	<b>61</b>
APPENDIX A: PRODUCT SPECIFICATIONS	61

# Chapter 1: Read Me First

## 1.1 Advisory Conventions

Four types of advisories are used throughout the user manual to provide helpful information or to alert you to the potential for hardware damage or personal injury. These are Notes, Important, Cautions, and Warnings. The following is an example of each type of advisory.

**Note:**

A note is used to emphasize helpful information

**Important:**

An important note indicates information that is important for you to know.



**Caution** A Caution alert indicates potential damage to hardware and explains how to avoid the potential problem.

**Attention** Une alerte 'attention' indique un dommage possible à l'équipement et explique comment éviter le problème potentiel.



**Warning!** An Electrical Shock Warning indicates the potential harm from electrical hazards and how to avoid the potential problem.

**Avertissement!** Un Avertissement de Choc Électrique indique le potentiel de chocs sur des emplacements électriques et comment éviterces problèmes.

## 1.2 Safety Information



### **Precaution on Battery Pack** **Précaution avec le bloc-pile**

Do Not Disassemble, Modify, or Insert Sharp Objects Into the Battery Pack. Electrolyte leakage, generation of heat, ignition or rupture may result.

*[FR] Ne pas démonter, modifier, ou insérer des objets pointus à l'intérieur du bloc-pile. Une fuite d'électrolyte, la génération de chaleur, l'amorçage ou la rupture peuvent être occasionnés.*

Do Not Short the Positive (+) and Negative (-) Terminals of the Battery. Generation of heat, ignition or rupture may result. When carrying or storing the device, do not place the battery pack together with articles that may contact electricity.

*[FR] Ne pas court-circuiter les bornes Positive (+) et Négative (-) de la pile, la génération de chaleur, l'amorçage ou la rupture peuvent être occasionnés. Lors du transport et du rangement de l'appareil, ne pas placer le bloc-pile en même temps que des articles pouvant créer un contact électrique.*

Do Not Apply Shocks to the Battery by Dropping It or Applying Strong Pressure to It. Electrolyte leakage, generation of heat, ignition or rupture of battery may occurs.

*[FR] Ne pas faire subir de choc à la pile en la laissant tomber ou en appliquant une forte pression dessus. Une fuite d'électrolyte, la génération de chaleur, l'amorçage ou la rupture peuvent être occasionnés.*

Do Not Charge the Battery Other Than Methods Those Specified In This Manual. If the battery is not charged using one of the specified methods, electrolyte leakage, generation of heat, ignition or rupture may result.

*[FR] Ne pas charger la pile par d'autres méthodes que celles spécifiées dans ce manuel. Si la pile n'est pas chargée en utilisant l'une des méthodes spécifiées, une fuite d'électrolyte, la génération de chaleur, l'amorçage ou la rupture peuvent être occasionnés.*

When the Battery Pack Has Deteriorated, Replace It with a New Battery. Continued use of a damaged battery pack may result in heat generation, ignition or battery rupture.

*[FR] Lorsque la pile est détériorée, la remplacer par une nouvelle pile. L'utilisation continue d'une pile endommagée peut occasionner une génération de chaleur, l'amorçage ou la rupture de la pile.*

Do Not Expose the Battery Pack to Excessive Heat, or Extreme Heat (Near Fire, in Direct Sunlight for example) Generation of heat, ignition or rupture may result

*[FR] Ne pas exposer le bloc-pile à une Chaleur Excessive, ou une Chaleur Extrême (Près d'un feu, sous la lumière du soleil par exemple) Une production de chaleur, l'amorçage ou la rupture peuvent être occasionnés*

Do Not Use the Battery Pack With Any Other Products. The battery pack is rechargeable and is only designed for this specific product. If it is used with a product other than the specified product, electrolyte leakage, generation of heat, ignition or rupture may result.

*[FR] Ne pas utiliser avec un autre produit La batterie est rechargeable et a été conçue pour un produit spécifique. Si elle est utilisée sur un produit différent de celui pour lequel elle a été conçue, des pertes d'électrolytes et une production de chaleur sont possibles, elle risque également de prendre feu ou de casser.*

Do Not Use This Product With Battery Other Than the One Specified.

*[FR] Ne pas utiliser ce produit avec une batterie autre que celle spécifiée*

Discontinue using device immediately if you notice the battery is swelling, or looks puffy or misshapen. Do not attempt to charge or use the device. Do not handle a damaged or leaking battery. Do not let leaking battery fluid come into contact with your eyes, skin or clothing.

*[FR] Si vous remarquez une pile gonflée, élargie ou anormale, cesser l'utilisation de l'appareil immédiatement. N'essayez pas de recharger l'appareil ou de l'utiliser. Ne pas manipuler une pile qui fuit ou qui est endommagée. Ne laissez pas de liquide qui fuit entrer en contact avec vos yeux, votre peau ou vos vêtements.*



## General Product Safety *Sécurité générale des produits*

- Do not block any ventilation openings. Do not place the product against a wall or in an enclosed space as doing so might impede the flow of cooling air.
- *[FR] Ne pas bloquer les ouvertures de ventilation. Ne pas placer le produit contre un mur ou dans un espace clos de façon à entraver la circulation de l'air de refroidissement.*
- Do not place the product near any heat sources such as radiators, warm air intakes, stoves or other heat-generating devices (including amplifiers or other heat producing equipment).
- *[FR] Ne pas placer le produit près d'une source de chaleur comme des radiateurs, les arrivées d'air chaud, poêles ou autres produits générant de la chaleur (y compris les amplificateurs ou autre équipement produisant de la chaleur.)*
- Protect the power cord from being crushed or pinched, particularly in the area of the plugs, any receptacles used, and the point of exit from the apparatus. Do not break off the ground pin of the power cord.
- *[FR] Empêcher le cordon d'alimentation d'être écrasé ou pincé, en particulier dans les zones de prises, des containers utilisés, et du point de sortie de l'appareil. Ne pas casser la broche de terre du cordon d'alimentation.*
- Do not disregard the safety that a polarized or grounded connection can provide. A polarized connection consists of two plugs, one of which is larger than the other. A grounded connection has two blades and a third one that is grounded. If the main plug provided cannot be inserted into your outlet, consult an electrician to replace your obsolete outlet.
- *[FR] Ne pas ignorer la sécurité qu'une prise polarisée ou une prise de terre peut prévoir. Une prise polarisée se compose de deux fiches, dont l'une est plus large que l'autre. Une prise de terre possède deux lames et une troisième qui est la terre. Si la fiche principale fournie ne peut être insérée dans votre prise, consultez un électricien pour remplacer votre prise obsolète.*
- Use only accessories specified by the manufacturer.  
*[FR] Utiliser uniquement les accessoires spécifiés par le fabricant.*

- This product should not be used near water such as bathtubs, sinks, swimming pools, wet basement, etc.  
*[FR] Ce produit ne doit pas être utilisé près de l'eau comme les baignoires, les évier, les piscines, les sous-sols humides, etc.*
- Use only with its transport carriage, stand, tripod, console or table specified by the manufacturer or sold with the product. When using a carriage, move the carriage assembly with the product carefully to avoid damage from falling over.
- *[FR] Utiliser uniquement avec son chariot de transport, support, trépied, console ou table spécifiés par le fabricant ou vendu avec le produit. Lors de l'utilisation d'un charriot, déplacez l'ensemble chariot avec le produit avec soin pour éviter tout dommage de chute.*
- Unplug this apparatus during lightning storms or when it is not being used for long periods.
- *[FR] Débrancher cet appareil durant les orages ou lorsqu'il n'est pas utilisé pendant de longues périodes.*
- Refer all servicing to qualified service personnel. A technical intervention is required when the apparatus has been damaged in any way, for example if the power cord or plug is damaged, liquid has been spilled or objects have fallen inside the unit, if the product has been exposed to rain or moisture, if it does not operate normally or if it has been dropped.
- *[FR] Confier toute réparation à du personnel qualifié. Une intervention technique est nécessaire lorsque l'appareil a été endommagé de quelque façon, par exemple si le cordon d'alimentation ou la fiche est endommagé, du liquide a été renversé ou des objets sont tombés à l'intérieur de l'unité, si le produit a été exposé à la pluie ou à l'humidité, s'il ne fonctionne pas normalement ou s'il a été jeté.*



## General Guideline *Directive générale*

It is recommended to reboot the device when some functions are defect or inactive. If it still can't solve the problems please contact your dealer or agent.

*Il est recommandé de redémarrer l'appareil lorsque certaines fonctions sont défectueuses ou inactives. Si le problème persiste, veuillez contacter votre revendeur ou votre agent.*

## 1.3 Handling and Maintenance



### General Guideline Guide Général

Keep the product at least 13 cm (5 inches) away from electrical appliances that can generate a strong magnetic field such as TV, refrigerator, motor, or a large audio speaker.

*[FR] Garder le produit au moins à 13 cm (5 pouces) de distance des appareils électriques qui peuvent générer un fort champ magnétique comme une télévision, un réfrigérateur, un moteur, ou un important haut-parleur.*

Do not place heavy objects on top of the tablet computer as this may damage the display.

*[FR] Ne pas placer d'objets lourds sur le dessus de l'ordinateur tablette cela peut endommager l'écran.*

The screen surface can be easily scratched. Use with care. Do not use paper towels to clean the display but use the included cleaning cloth. Avoid touching it with a pen or pencil.

*[FR] La surface de l'écran peut être facilement rayée. Utiliser avec précaution. Ne pas utiliser de serviette en papier pour nettoyer l'écran mais utiliser le chiffon de nettoyage inclus. Éviter de toucher avec un stylo ou un crayon.*

To maximize the life of the backlight in the display, allow the backlight to turn off as a result of power management automatically. Avoid using a screen saver or other software that prevents power management from working.

*[FR] Pour maximiser la durée de vie du rétroéclairage de l'écran, autoriser le rétroéclairage résultant de la gestion de l'alimentation. Éviter d'utiliser un économiseur d'écran ou un autre logiciel empêchant la gestion de l'alimentation de fonctionner.*



### Cleaning Guideline Guide de net toyage

Use a soft cloth moistened with water or a non-alkaline detergent to wipe the exterior of the product.

*[FR] Utiliser un chiffon doux humidifié avec de l'eau ou un détergeant non alcalin pour essuyer l'extérieur du produit.*

Gently wipe the display with a soft, lint-free cloth. Do not use alcohol or detergent on the product.

*[FR] Essuyer délicatement l'écran avec un chiffon doux non pelucheux. Ne pas utiliser d'alcool ou un détergent sur le produit.*



### Touchscreen Guideline Guide de l'écran tactile

Use your finger or the stylus on display. Using sharp or metallic objects may cause scratches and damage the screen, thereby causing errors.

*[FR] Utiliser votre doigt ou le stylet sur l'écran. L'utilisation d'un objet pointu ou métallique peut provoquer des rayures.*

Use a soft cloth to remove dirt on display. The touchscreen surface has a special protective coating that prevents dirt from sticking to it. Not using a soft cloth may cause damage to the special protective layer on the touchscreen surface. To clean off hard to remove dirt, blow some steam on the particular area, and gently wipe away using a soft cloth.

*[FR] Utiliser un chiffon doux pour enlever la poussière sur l'écran. La surface de l'écran tactile a un revêtement protecteur spécial empêchant la saleté de se coller à lui. Ne pas utiliser un chiffon doux peut endommager le revêtement spécial sur la surface de l'écran tactile. Pour nettoyer les saletés plus difficiles à enlever, souffler de la buée sur la zone particulière et essuyer doucement avec un chiffon doux.*

Do not use excessive force on display. Avoid placing objects on top of the display as this may cause the glass to break.

*[FR] Ne pas utiliser une force excessive sur l'écran. Éviter de placer des objets au dessus de l'écran cela pourrait provoquer une cassure du verre.*

When there is a noticeable discrepancy in the operation of the touchscreen function (your touch does not correlate to the proper location on the screen), recalibrate the touchscreen display.

*[FR] Lorsqu'il y a un écart sensible dans le fonctionnement de l'écran tactile (votre contact ne correspond pas à la bonne position sur l'écran), recalibrer l'écran tactile.*

## 1.4 Declaration of Conformity (DoC)

### FCC Statement

This device complies with part 15 FCC rules.



Operation is subject to the following two conditions:

- This device may not cause harmful interference.
- This device must accept any interference received including interference that may cause undesired operation

This equipment has been tested and found to comply with the limits for a class "B" digital device, pursuant to part 15 of the FCC rules. These limits are designed to provide reasonable protection against harmful interference when the equipment is operated in a commercial environment. This equipment generates, uses, and can radiate radio frequency energy and, if not installed and used in accordance with the instruction manual, may cause harmful interference to radio communications. The operation of this equipment in a residential area is likely to cause harmful interference in which case the user will be required to correct the interference at his own expense.

### CE Notice (European Union)



Electromagnetic Compatibility Directive (2014/30/EU)

- EN55024: 2010/ A1: 2015
  - IEC61000-4-2: 2009
  - IEC61000-4-3: 2006+A1: 2007+A2: 2010
  - IEC61000-4-4: 2012
  - IEC61000-4-5: 2014
  - IEC61000-4-6: 2014
  - IEC61000-4-8: 2010
  - IEC61000-4-11: 2004
- EN55032: 2015/AC:2016
- EN61000-3-2:2014
- EN61000-3-3:2013

Low Voltage Directive (2014/35/EU)

- EN 60950-1:2006/A11:2009/A1:2010/A12:2011/ A2:2013

This equipment conforms with the requirement of the following EU legislation and harmonized standards. The product also complies with the Council directions.



## Chapter 2: Getting Started

This chapter tells you step by step how to get the M116K Tablet Computer up and running.

### 2.1 Introduction

Congratulations on purchasing Winmate® 11.6-inch Windows Rugged Tablet M116K.

The M116 platform is a next-generation Windows rugged tablet series designed to boost efficiency in a mobile, versatile form factor. The large 11.6-inch sunlight-readable, full HD display allows for a premium viewing experience no matter where work takes place. The M116K allows for powerful performance with the 7th generation Intel Core i5 processor for all-day use with a hot-swappable battery design. Multiple wireless connectivity options and data capture modules allow users to complete their tasks reliably, from warehouses to vehicle-mounted to field external service use. All these tools suited for productivity encased in IP65 water and rugged dustproof housing with MIL-STD 810G specs ensure that the M116K is the ultimate rugged Tablet designed with mobile productivity in mind.

#### Highlights

- Intel® Core™ i5-7300U 2.60 GHz processor
- 11.6" 1920 x 1080 LED panel with direct optical bonding
- IP65 water and dustproof with MIL-STD-810G rugged housing
- Optional integrated 1D/2D Barcode Reader and HF RFID for data collection
- Removable battery with hot-swap function for all-day productivity
- Wireless connectivity 802.11ac Wi-Fi, BT 5.0, 4G LTE, GPS
- Optional GigaLAN Port

## 2.2 Unpacking

Check and identify the supplied accessories:

- **Tablet Computer**

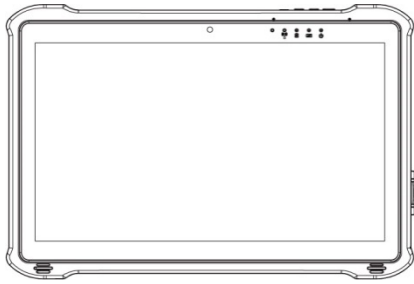

- **Standard Battery BM101**



- **Power Adapter**



- **Power Cord and Plugs**



- **Capacitive Stylus DS-M101**

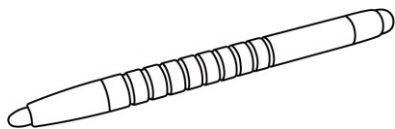

- **Quick Start Guide & Driver CD**

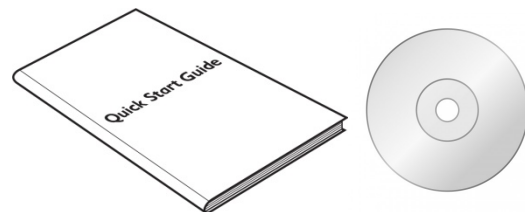

Your package may include other optional accessories based on your order:

- Desk Dock
- Vehicle Dock DD-M116 (w/o VGA output)
- Vehicle Charger
- High Capacity Battery BL101
- Hand Strap HS-M116
- Battery Charger BC-M101-2N
- VESA Mount Kit VS-M116
- Shoulder Strap SS-M116
- Carry Bag CB-M116
- Micro HDMI Cable
- Gigabit Ethernet Adapter
- RS232 Cable
- USB Hub Adapter
- Vehicle Cradle VC-M116 (Charging only)

## 2.3 Description of Parts

Dimensions: 300.67 x 201.97 x 22.5 mm

Front:

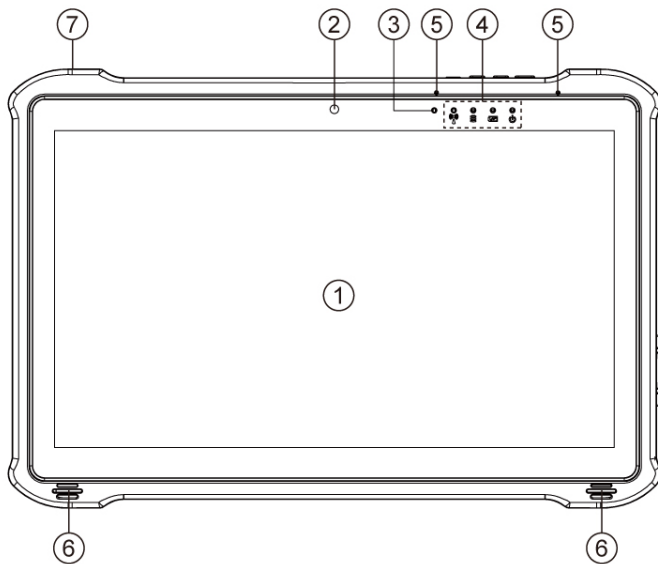

Left:

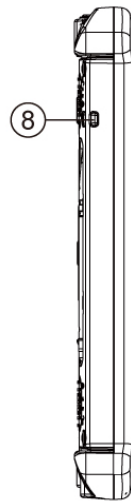

Right:

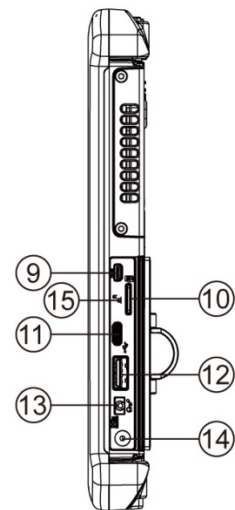

No	Item	Description
1	11.6" PCAP Touchscreen	11.6-inch display with LED backlight acts as one of the inputs for the Tablet Computer.
2	Front Camera	2 MP front camera.
3	Light Sensor	Indicates the environment brightness.
4	LED Indicators	Show the current status of the Tablet Computer: Power, Battery, HDD, RF
5	Digital Mic with Noise Cancellation	Use during video recordings and communications.
6	Speakers	Emit sounds.
7	All-Around Rubber	Protects the Tablet Computer from drops.

### Front LED Indicator Details:



No	Item	Description
8	String Hole	Use to attach a wrist strap or other accessories.
9	Micro HDMI	HDMI output to an external display.
10	Micro SDXC slot	Memory card reader port for Micro SDXC card.
11	USB 3.0 Type-C	High speed USB port connects to USB devices, such as USB flash drive, mouse, keyboard, printer, etc. <b>Note:</b> The USB Type-C connector follows USB 3.0 standard, which does not support Alternate Mode (ALT) or USB Power Delivery (USB-PD).
12	USB 3.0 Type-A	USB 3.0 port connects to USB devices, such as USB flash drive, mouse, keyboard, printer, etc.
13	Mic In/Line Out	Headset or headphone can be connected (Mic is only supported with 3.5mm 4-pin headset)
14	Power Jack	DC power input jack that accepts 19V DC power input.
15	Reset Button	Press to reset the Tablet Computer.

**Rear:**

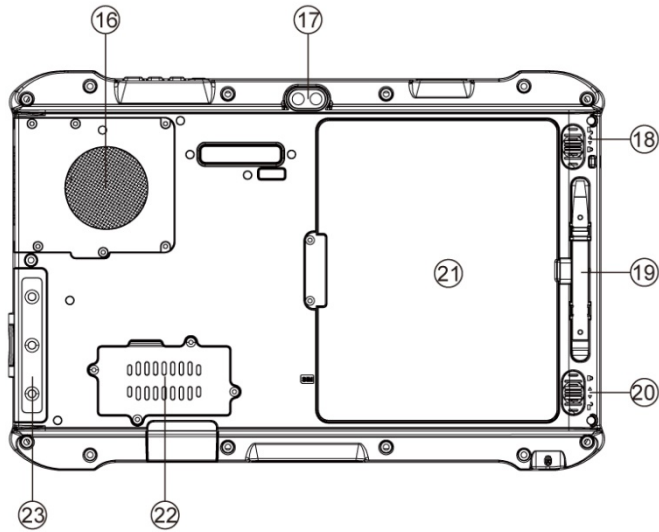

**Top:**

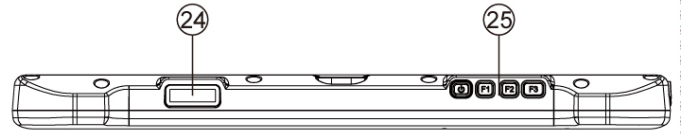

**Bottom:**

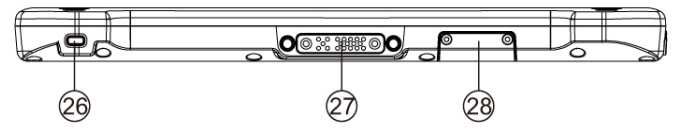

No	Item	Description
16	Fan Intake	Intake for waterproof fan.
17	Rear Camera	8MP rear camera with autofocus. Captures photos and videos.
18	Battery Release	Slider Spring-loaded slider that latches the battery in.
19	Touch Pen Slot	Pen holder slot to store touch pen.
20	Battery Lock Latch	Latch to lock the battery in place once battery is inserted. Not spring-loaded.
21	Battery*	Standard: Hot-swappable 7.7V typ. 5900 mAh Li-Polymer Battery (2S1P), Optional: 7.4V typ. 10280 mAh Li-Polymer Battery (2S2P)
22	Service Window	Provide access to 4G LTE Module.
23	Waterproof I/O Cover	Protects I/O ports from water and dust.



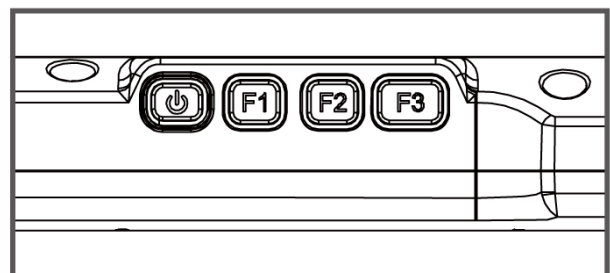

No	Item	Description
24	Optional Barcode Scanner	Barcode Scanner for reading of 1D/2D barcode.
25	Physical Buttons: Power, F1, F2, F3	Press power button to turn on the Tablet. Long press power button to hard turn off the Tablet. Programmable function key can be configured by Hottab Utility.
26	Kensington Lock	Use to attach tablet computer around a table leg or another secure location.
27	Docking Connector	Port to docking solutions such as vehicle docking to provide power and external antenna.
28	Expansion connector for (Optional)	GigaLAN expansion connector.

**Top Buttons Details:**



\* **Note:** Micro SIM card slot is located in the battery compartment. Please remove the battery first to access the Micro SIM card slot.

## 2.4 Indicators

Icon	Indicator	Description
	Power Indicator	<b>Blue</b> – Tablet is ON <b>No light</b> – Tablet is OFF
	Battery Status	<b>Orange</b> –AC adapter is plugged in and charging <b>Green</b> –AC adapter is plugged in and battery is full charged <b>Solid Red</b> - Low battery (<10%) <b>Blinking Red</b> – Battery is being hot swapped. <b>No light</b> – Battery is in use and more than 10%
	Disk Activity Indicator	<b>Green</b> - Disk Activity <b>No light</b> - Disk Idling
	RF Communication	<b>Green</b> - One of Wi-Fi/BT/WWAN/GPS is ON <b>No light</b> - Wi-Fi/BT/WWAN/GPS are all OFF

## 2.5 Hotkey for Specific Functions

Physical buttons, in addition to its dedicated functions, can also be used to emulate commonly used keyboard keystrokes. Under a different scenario, a single physical button or a combination of physical buttons provide different keyboard keystrokes, which are specified below:

In POST (before Windows boots up):

Buttons	Keystroke
F1	F6 to enter Recovery Menu
F2	Esc to enter BIOS setup screen

In Windows:

Buttons	Keystroke
Menu	Hottab Quick Access
F1	Default: Web Browser
F2	Default: Camera
Power	Power ON/ OFF
F1+F3	Ctrl + Alt + Del
F3	Default: Calculator

## 2.6 First-Time Operation

To get started:

1. Install the SIM card.
2. Install the storage card.
3. Install the battery.
4. Charge your Tablet.
5. Start the Tablet.

### 2.6.1 Installing Battery



**Caution** Disconnect any cords connected to the tablet computer before installing or removing the battery procedure.

**Attention** Débranchez tous les cordons connectés à la tablette avant l'installation ou la procédure de retrait de la batterie.

*To install the standard battery pack:*

1. Turn the Tablet over, back facing up.

2. Insert the battery with the connector-pins side first, and then lower the battery into the battery compartment. Make sure the battery is completely lowered into the compartment. Once fully inserted, the Battery Release Slider automatically locks. The battery will be flat against the housing once fully inserted.
3. Push the Battery Lock to the “**Locked**” position.

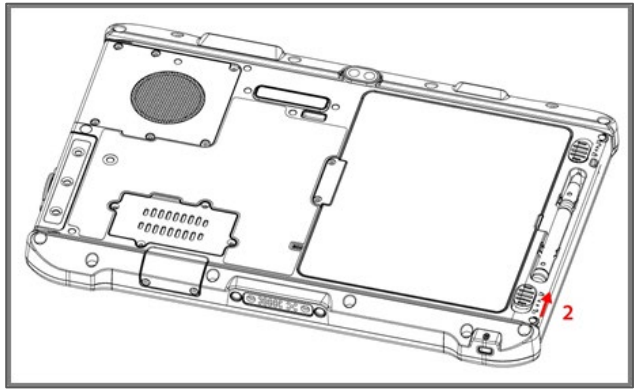
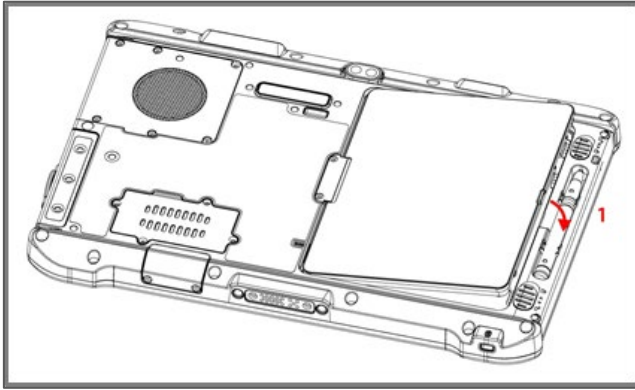

#### To remove the battery pack:

1. Shut down the Tablet (or put it into sleep mode). Turn the tablet computer over, back facing up.
2. Push the Battery Lock Latch it to the “**Unlocked**” position.
3. Pull up and hold the Battery Release Slider that is spring-loaded.
4. Lift the battery out using the opening on the side of the battery compartment.

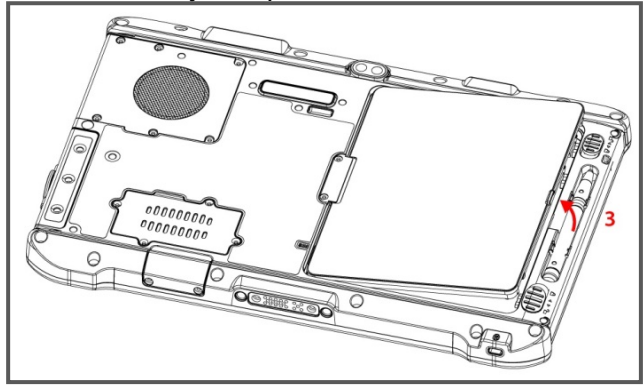
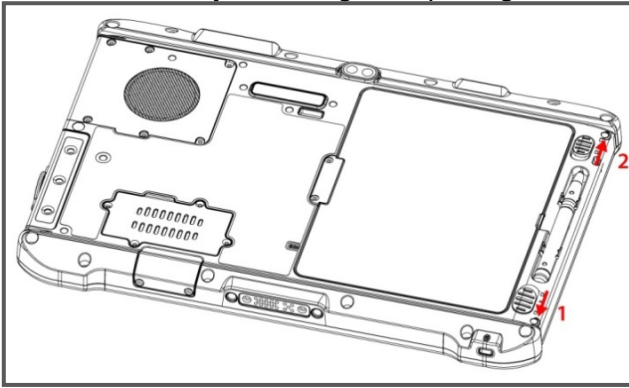

## 2.6.2 Installing a Micro SD Card

Your Tablet supports additional storage with an optional micro SDXC card.

#### To install Micro SDXC Card:

1. Open I/O protective cover by pulling out the latch.
2. Insert micro SDXC card into slot with contacts facing down.
3. Press the card in to ensure that it is seated properly.
4. Close I/O protective cover.

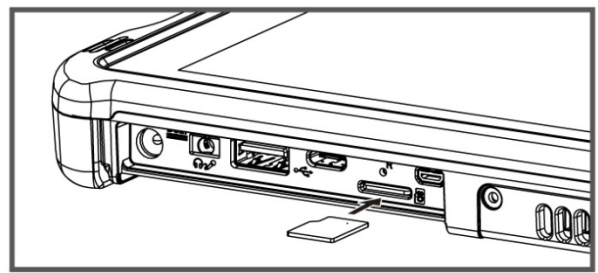
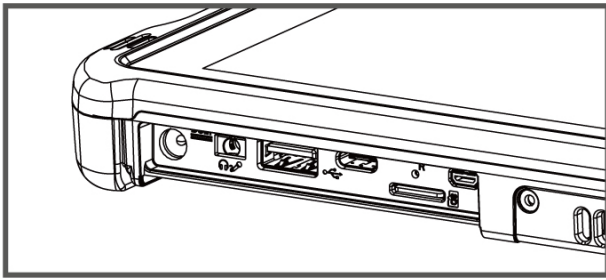

#### To remove Micro SD Card:

1. Open I/O protective cover by pulling out the latch.
2. Push and release the micro SD card to unlock it.
3. Pull out the micro SD card.

### 2.6.3 Installing 4G LTE Module

Notice that 4G LTE feature is optional and may not be supported by your device. Check your order specifications for more details.

The Tablet Computer supports 4G LTE data connection and fits a Micro-SIM card. Before installing fits a Micro-SIM card, please install the 4G LTE module.

To install the LTE module:

Tools Needed:	<b>Service Windows</b> Screw: M2x5, 4 pc Screwdriver: Philips Type , Size #0 , for M2 screws, torque: 2.0 ± 0.5 kgf.cm	<b>4G LTE Module</b> Screw: M2x3.5, 1 pc Screwdriver: Philips Type , Size #0 , for M2 screws, torque: 2.0 ± 0.5 kgf.cm
---------------	--	--

**1** Remove four screws and remove the service window.

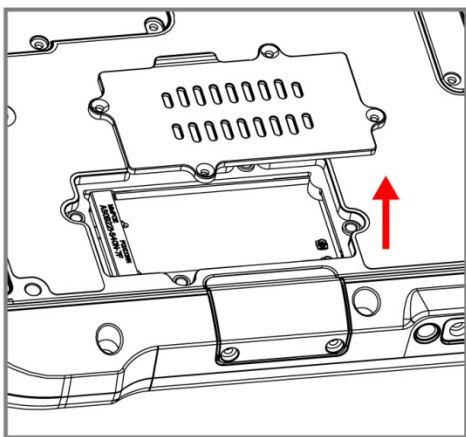

**2** Insert module card to its slot and connect two cables to the 4G LTE module card. **Do not to damage the connected cables!**

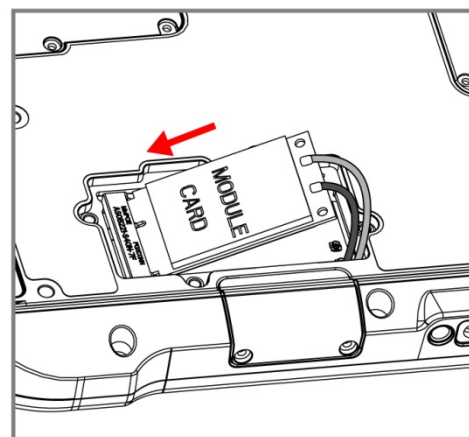

**3** Push the 4G LTE module card down to insert it to its position and fasten one screw. Accurately route the cables. **Do not bend cables! Do not pinch/ squeeze the cables!**

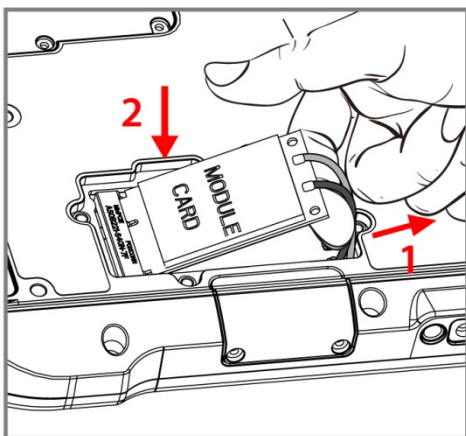

**4** Re-insert the service window and fasten with the four screws.

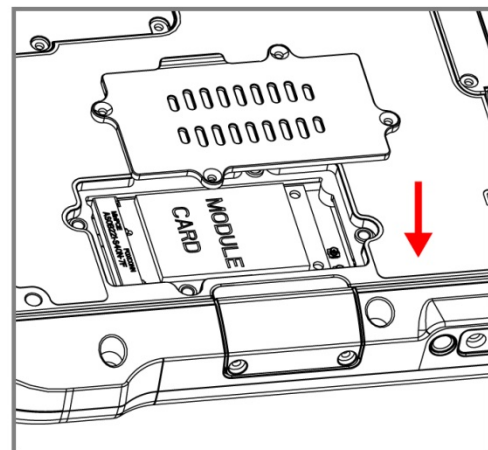

**Caution** When re-inserting 4G LTE module, please pay attention to cable routing. Make sure the cable module does not get squeezed.

**Attention** Lorsque vous réinsérez le module 4G LTE, faites attention au routage des câbles. Assurez-vous que le module de câble n'est pas coincé.

## 2.6.4 Installing SIM card (For 4G/LTE Equipped Devices)

Notice that 4G LTE feature is optional and may not be supported by your device. Check your order specifications for more details.



**Caution** Disconnect any cords connected to the Tablet Computer before installing or removing the battery procedure.

**Attention** Débranchez tous les cordons connectés à la tablette avant l'installation ou la procédure de retrait de la batterie.

**1** Remove the battery as described in the previous section.

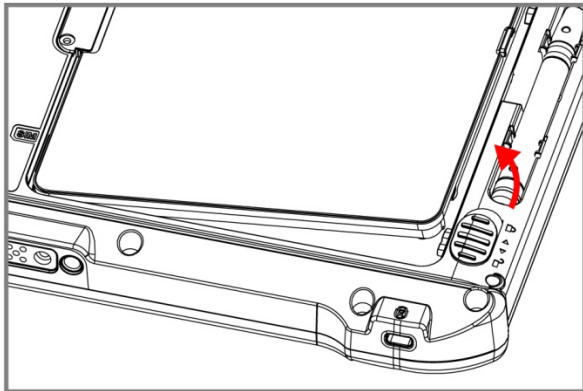

**2** Open the SIM-card slot rubber protection cover.

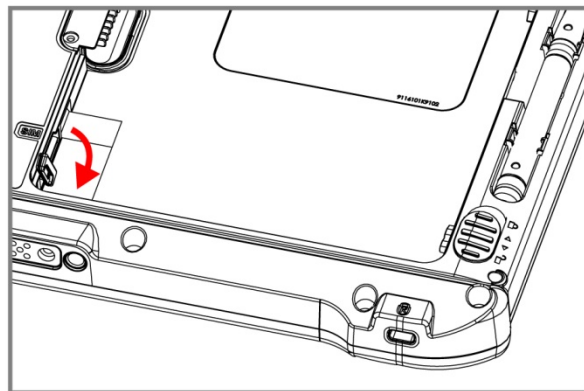

**3** Insert SIM-Card all the way in. **Chip/contact facing down.**

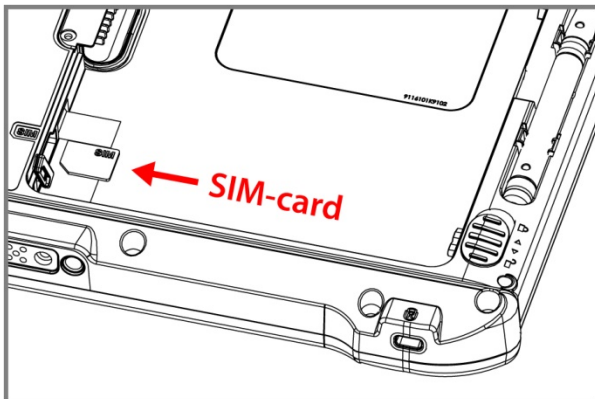

**4** Close the SIM-card slot rubber protection cover.

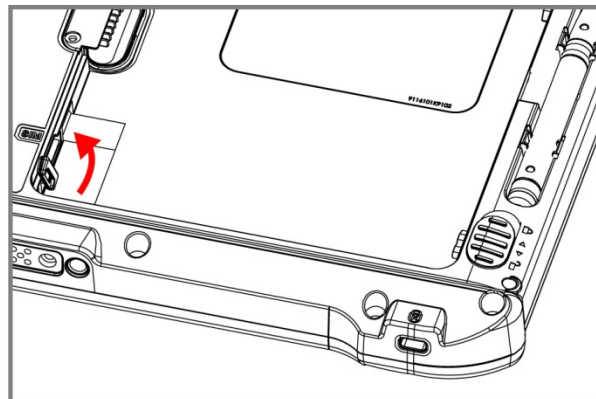

**5** Re-insert the battery. Make sure to battery is fully inserted and is flat against the housing.

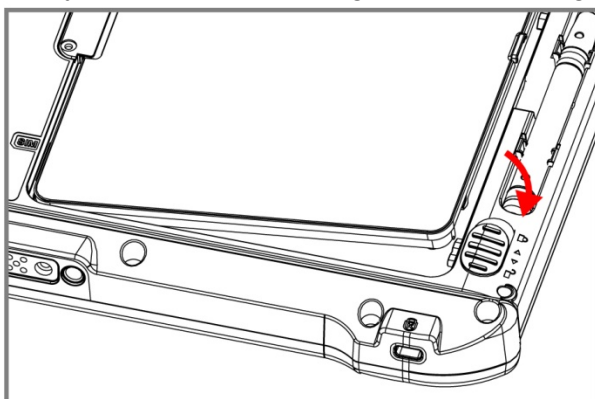

**6** Push the Battery Lock to the "Locked" position.

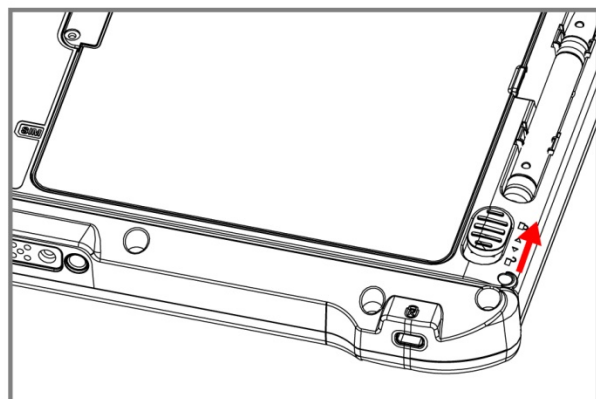



## 2.6.5 Charging Your Tablet

The Tablet operates either on external AC power or internal battery power. It is recommended to use AC power when you start up the Tablet for the first time.



**Caution** Use only the AC adapter included with your Tablet Computer. Using other AC adapters may damage the Tablet Computer and the Battery.

**Attention** Utilisez uniquement l'adaptateur secteur fourni avec votre ordinateurne tablette. L'utilisation d'autres adaptateurs secteur peut endommager la tablette tactile et la batterie.

To connect a tablet to AC power:

1. Open I/O protective cover by pulling out the latch.
2. Plug the DC cord of the AC adapter into the power jack of the Tablet Computer.
3. Plug the AC power cord into the AC adapter.
4. Plug the AC power cord into the electrical outlet.

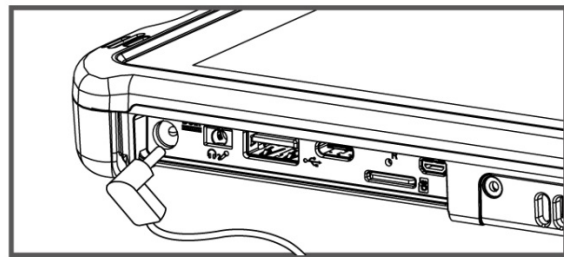
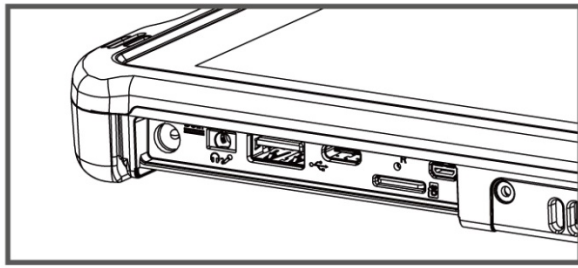

The battery LED indicator shows different battery states:

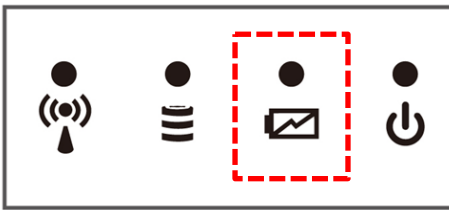

**Orange** - AC adapter is plugged in and the battery is charging.

**Green** - AC adapter is plugged in and the battery is fully charged.

**Solid Red** - Low battery level (<10%).

**Blinking Red** - Battery is being hot swapped.

**No light** - Battery is in use and charged (>10%).

## **2.6.6 Using LAN Port (RJ45)**

Notice that the LAN Port (RJ45) is optional and may not be supported by your device. Check your order specifications for more details.

1. Connect the tablet PC to external devices using LAN cable.

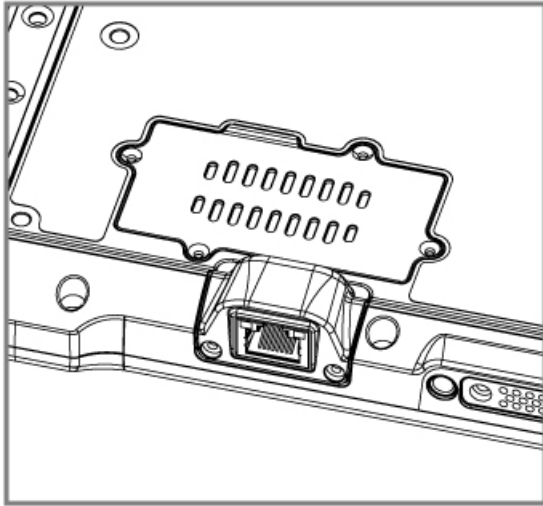

## **2.6.7 Starting the Tablet**



**Important:** When powering on the device for the first time, please make sure there's no interruption during the Windows setting up process, for example, accidentally powering off. If it happened, please access the recovery menu by pressing **Fn1** button on the front bezel to initiate the recovery process.

Press and hold the power button for **3 seconds** until the blue LED power indicator light up.



**Note:** Do not press the power button repeatedly. Do not perform the following operations until the Disk Activity Indicator off

- Connecting or disconnecting the AC adapter
- Pressing the power button
- Touching the tablet buttons, screen, or external keyboard/mouse

To power off the Tablet Computer:

1. Make sure you have closed any programs that are open on the Desktop. Start Screen apps don't need to be closed.
2. Tap on the **Settings** charm.
3. Tap on **Power**.
4. Tap on **Shut Down**.
5. Wait for Tablet Computer to power off.



**Note:** The computer will forcibly be powered off if the power button is pressed and held for **6 seconds or longer**.

## Chapter 3: Setting Up Windows for the First Time

This chapter details how to setup the Windows that may be installed on the Tablet for the first time.

### 3.1 Introduction

The M116K Tablet Computer operates on Windows 10 IoT Enterprise operating system.



**Caution** Make sure the battery is full charged before starting the Tablet Computer for the first time with internal battery power.

**Attention** Assurez-vous que la batterie est complètement chargée avant de démarrer la tablette tactile pour la première fois avec la batterie interne.

**Public network:** Select this location if you do not recognize all the computers on the network (For example, you are in a coffee shop or airport, or you have mobile broadband.) This is a public network and is *not* trusted. Select the location where you will most often use the computer.

### 3.2 Setting up Windows 10 IoT Enterprise

Follow the steps below to complete the Windows 10 IoT Enterprise setup process.

1. Press the power button to turn on the computer.
2. First, select your country/region, your preferred app language, your preferred keyboard layout, and your time zone, then tap **Next**.

Hi there

Let's get a few basic things out of the way.

What's your home country/region?

United States

What's your preferred app language?

English (United States)

What keyboard layout would you like to use?

US

What time zone are you in?

(UTC-08:00) Pacific Time (US & Canada)

Next

3. On the **Here's the legal stuff** screen, read through the disclosures, then tap **Accept**.

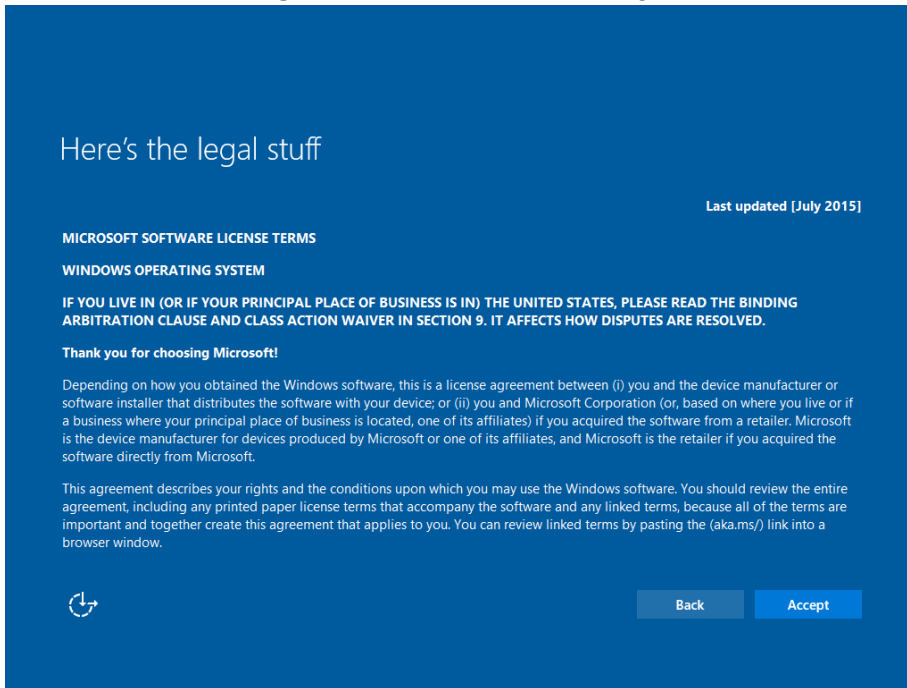

4. Windows will then try to connect to network. Tap **Skip this step** to continue without a wireless connection as you can then set up the network later.
5. On the **Get going fast** screen, click **Use Express settings** for the fastest setup. If you would like more information, tap **Learn more**, or if you would like to select your own options, click **Customize settings**.

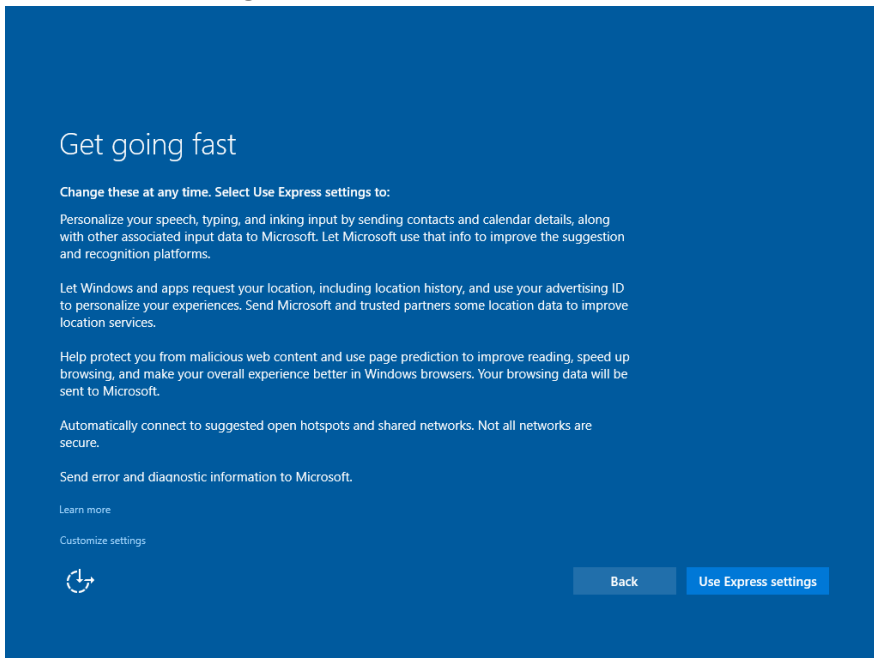

- To create a local account, type your User name, password, and Password hint in the fields provided, and then tap **Next**.

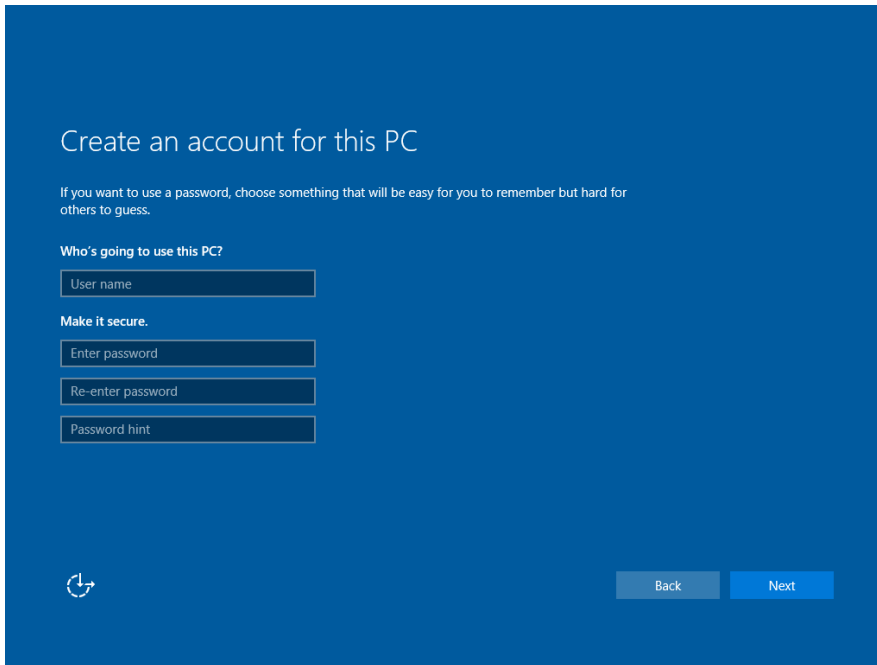

The screenshot shows the 'Create an account for this PC' screen. At the top, it says 'Create an account for this PC'. Below that, a note reads: 'If you want to use a password, choose something that will be easy for you to remember but hard for others to guess.' The screen is divided into two sections: 'Who's going to use this PC?' and 'Make it secure.'. Under 'Who's going to use this PC?', there is a text input field labeled 'User name'. Under 'Make it secure.', there are three text input fields: 'Enter password', 'Re-enter password', and 'Password hint'. At the bottom left, there is a circular refresh icon. At the bottom right, there are two buttons: 'Back' and 'Next'.

- The initial setup screens are complete, and the desktop is displayed.
- Read any introductory screens describing features of your computer, and tap **Next** upon completing each. You are now done with the initial setup process.

## Chapter 4: Operating the Device

This chapter describes how to operate the M116K Tablet Computer, including camera, Hottab, barcode, RFID, WWAN, WLAN, GPS features.



**Note:** Please download the SDK from Winmate Download Center.

>> M116K >> Development Kit or check the Driver CD which is shipped with the Tablet.

Please notice that HF RFID reader, Barcode reader are optional module, please make sure user have ordered the module before using the SDK.





### 4.1 Hottab Introduction

Hottab provides quick access to the Tablet's functions and features, such as setting up shortcuts, using camera, powering on/off built-in devices, programming function key, and changing power management.

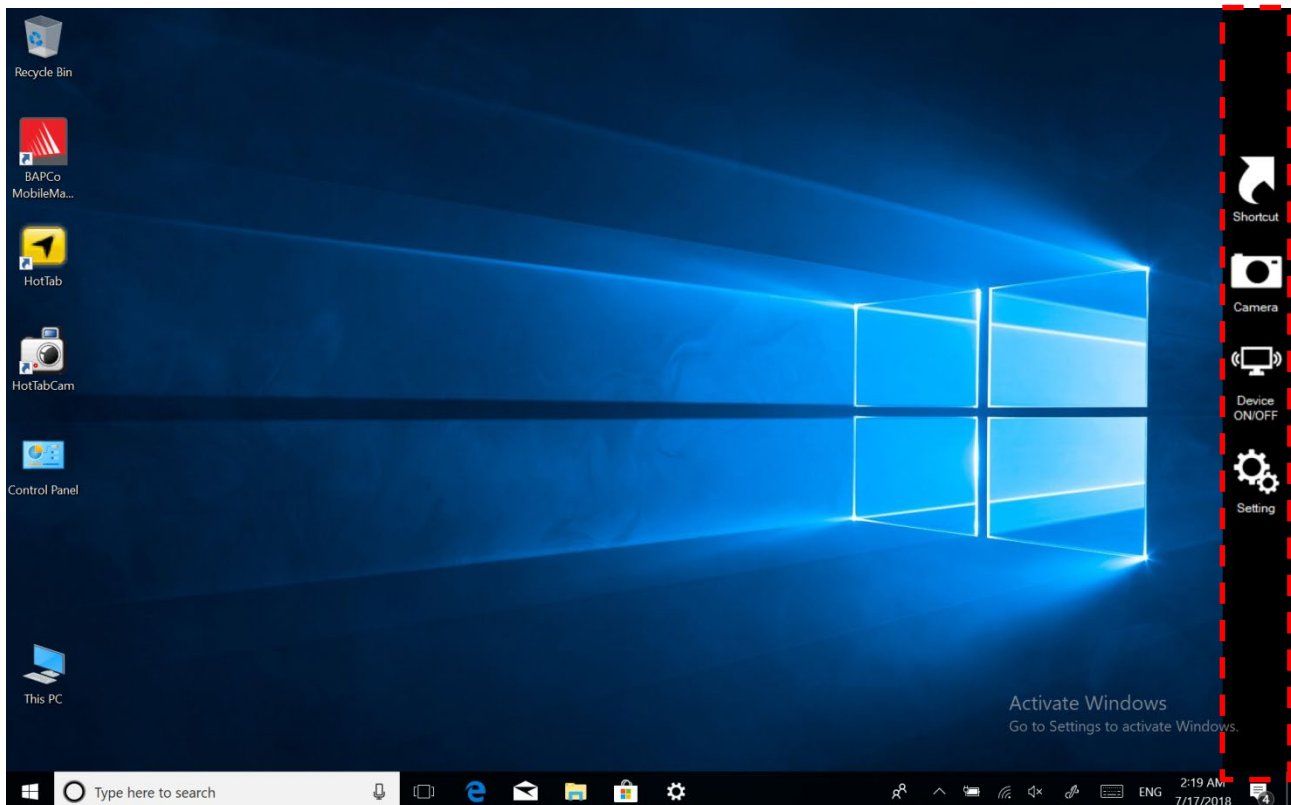
As Windows starts up, Hottab starts and runs in the background. To open the Hottab control utility launch the Hottab Utility .

The main user interface is located on the right side of the screen. There are 4 main menu options: Shortcuts, Camera, Device ON/OFF, and Settings. Operations and functions on each menu options is explained in detail in the coming section.



Icon	Description
 Shortcuts	Allows users to configure short cut to quickly access programs with a few tabs.
 Camera	Allows users take a picture or record a video. User can also adjust setting related to camera in this menu option.
 Device ON/OFF	Enables/disables tablet computer's hardware functions. The configurable functions are Wi-Fi, WWAN (3G/4G/LTE), GPS, Bluetooth, Camera, LED indicators, Barcode Reader, RFID Reader, and GPS Antenna routing options.
 Settings	Provides users information such as PC Information, Battery status, and also device settings such as power management setting, and function key mappings.

## 4.2 Shortcuts

Hottab Shortcuts Menu provides an user-friendly interface to configure on-screen software short cuts and allow users to quickly access programs with a few tabs. The Shortcuts menu offers 8 empty slots to store user's desired quick access. Shortcuts can be mapped to any of the executable files (.exe) installed on the Tablet.

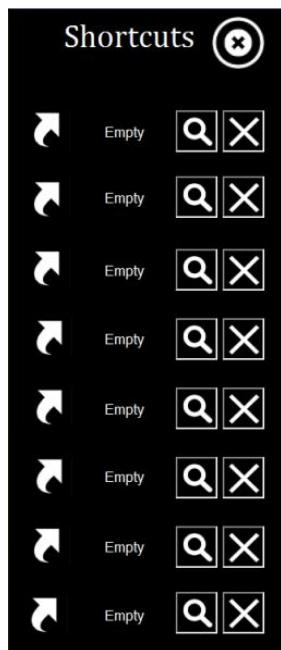

### Short Cut Menu:



### To store a new shortcut:

1. Launch the Hottab .
2. Tap on the **Shortcuts** button.
3. Tap on  button of any empty slot.
4. An on screen file browser will appear.
5. Browse to find the desired application to have shortcut.
6. Click "Open" to save the shortcut.

### To remove an saved shortcut:

1. Launch the Hottab .
2. Tap on the **Shortcuts** button.
3. Tap on the  button of any saved slot to remove
4. Shortcut will be removed, and once again show "Empty" to indicate slot is empty.

Tap on the  button will hide the Hottab Utility Menu.

### Using the Hottab shortcuts:

1. Launch the Hottab .
2. Tap on the **Shortcuts** button.
3. Tap on the saved shortcut items to access saved programs.

## 4.3 Using Camera

This Hottab menu option allows users take a picture or record a video. Before use, make sure the camera is powered on under Devices ON/OFF menu with the following scenarios.





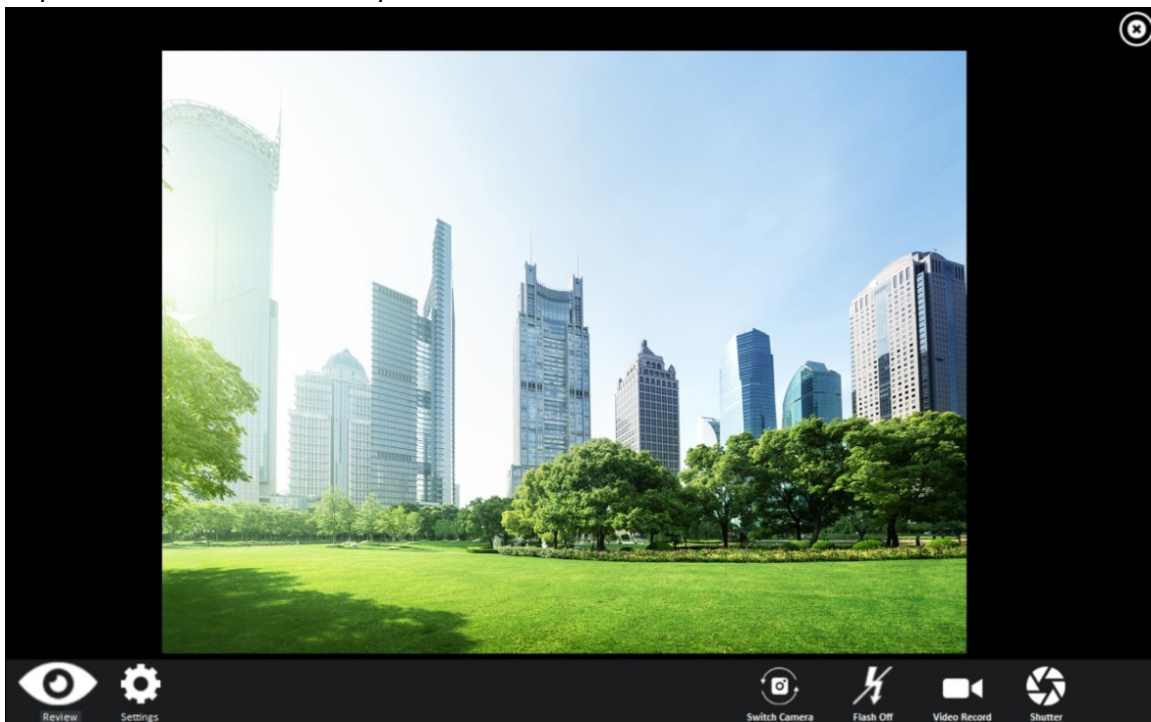

To open camera interface:

1. Launch the Hottab Utility .
2. Tap on "Device ON/OFF" button to check the built-in devices status.
3. Check the status color of the **Camera** icon:

Item	Status Color	Description
 <b>Camera</b>	Orange	Camera is enabled.
	White	Camera is disabled.

4. If the Camera is disabled (white), tap on the *Camera* icon to enable it (orange).
5. Click on the back arrow on top to go back to Hottab main menu.
6. Tap on the *Camera* icon to open Camera menu.



No	Item	Description
1	<b>Review</b>	 Review
2	<b>Settings</b>	 Opens Camera settings page. Available Settings: <ul style="list-style-type: none"> <li>• <b>Picture Save:</b> modify/inspect saved location for pictures.</li> <li>• <b>Video Save Folder:</b> modify/inspect saved location for video recordings.</li> <li>• <b>Picture Quality:</b> Picture compression quality.</li> </ul>
3	<b>Camera Switch</b>	 Switch between front camera or rear camera.
4	<b>Flash Control</b>	 Enables/ Disables LED Flash when taking picture.
5	<b>Video Record</b>	 Tap to Start, and press again to stop recording.
6	<b>Shutter Camera</b>	 Camera Shutter Button. Tap to take picture.
7	<b>Exit</b>	 Exits the Camera and hide Hottab Utility.



## 4.4 Adjusting LED Brightness

### 1. Open EZConfig-Scanning V4\_IE Icon

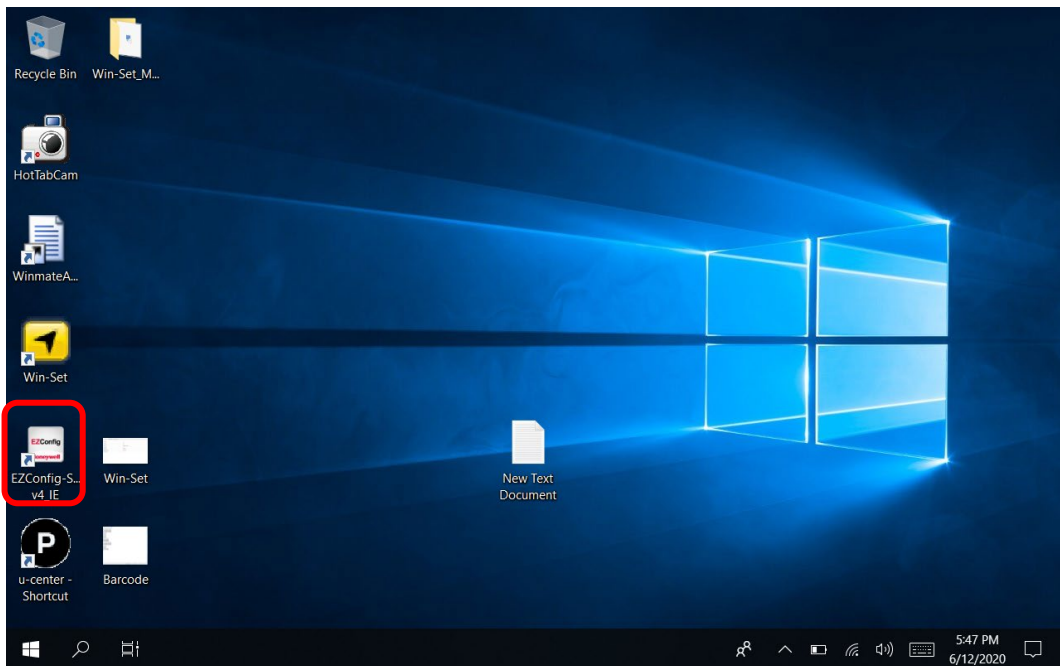

### 2. Open Connected Device

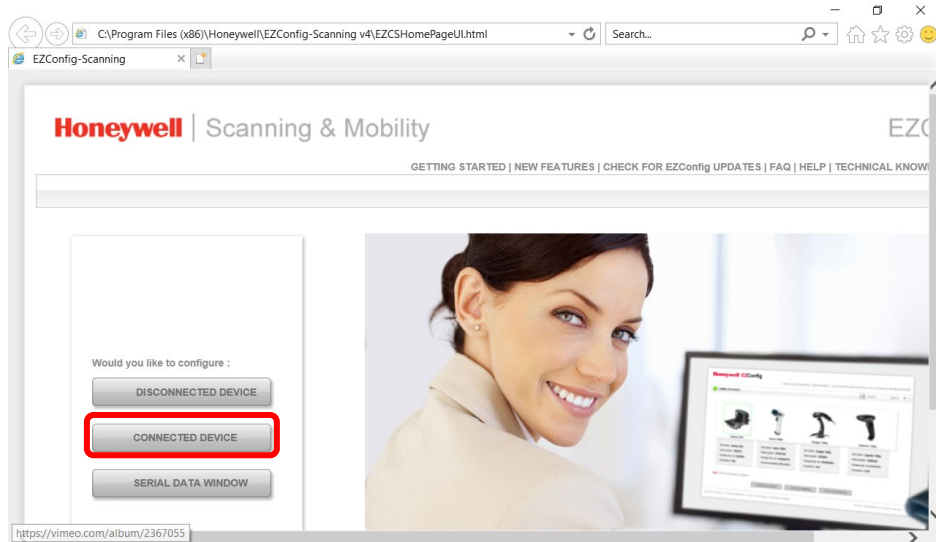

### 3. Open Connected Device

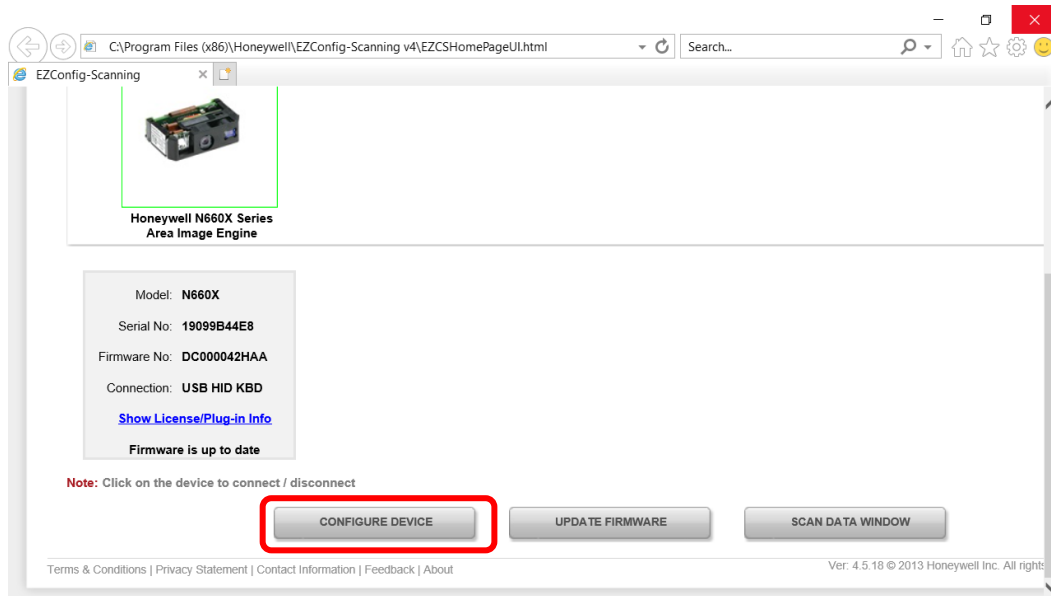

4. Open Settings → Device Settings → LED illumination - Manual Trigger **Setting change 120**

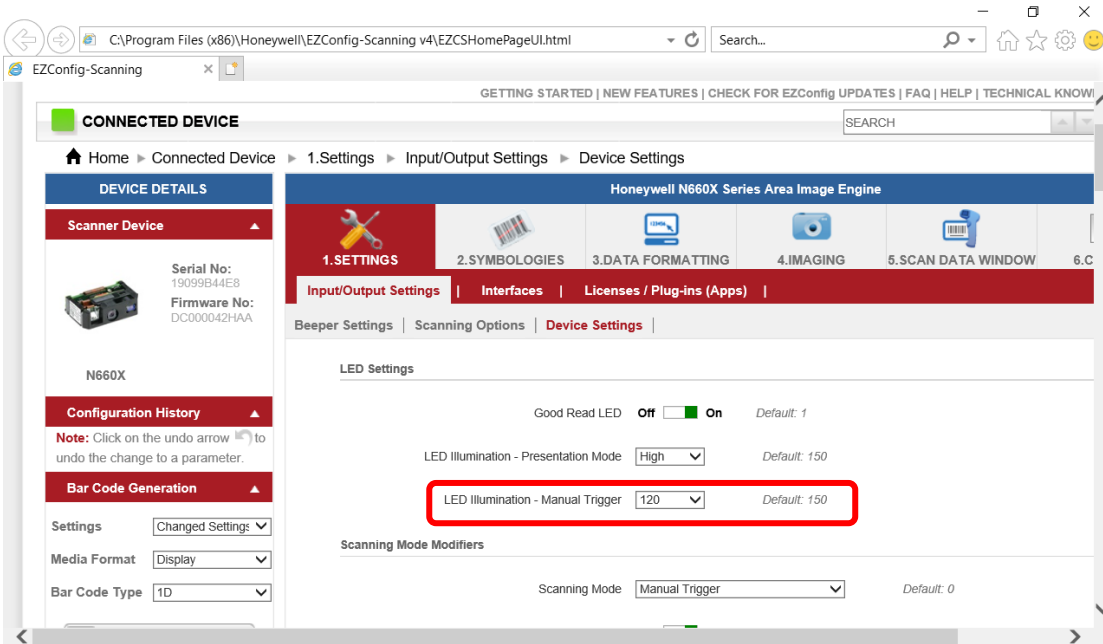

5. Save To Device

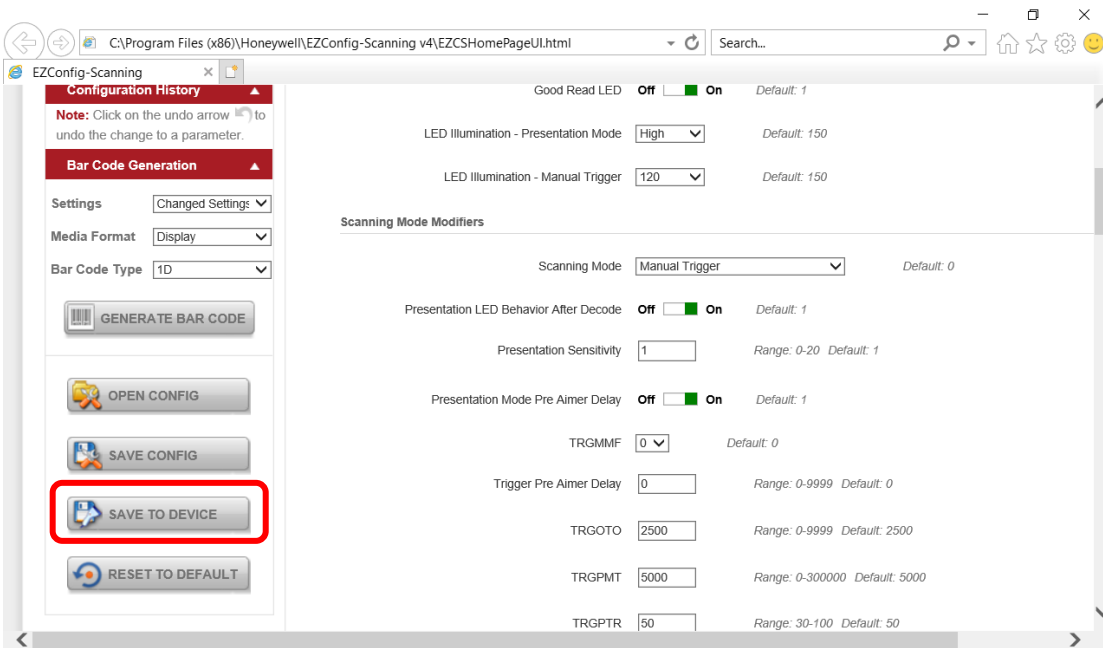

## 6. Open Win-Set Icon

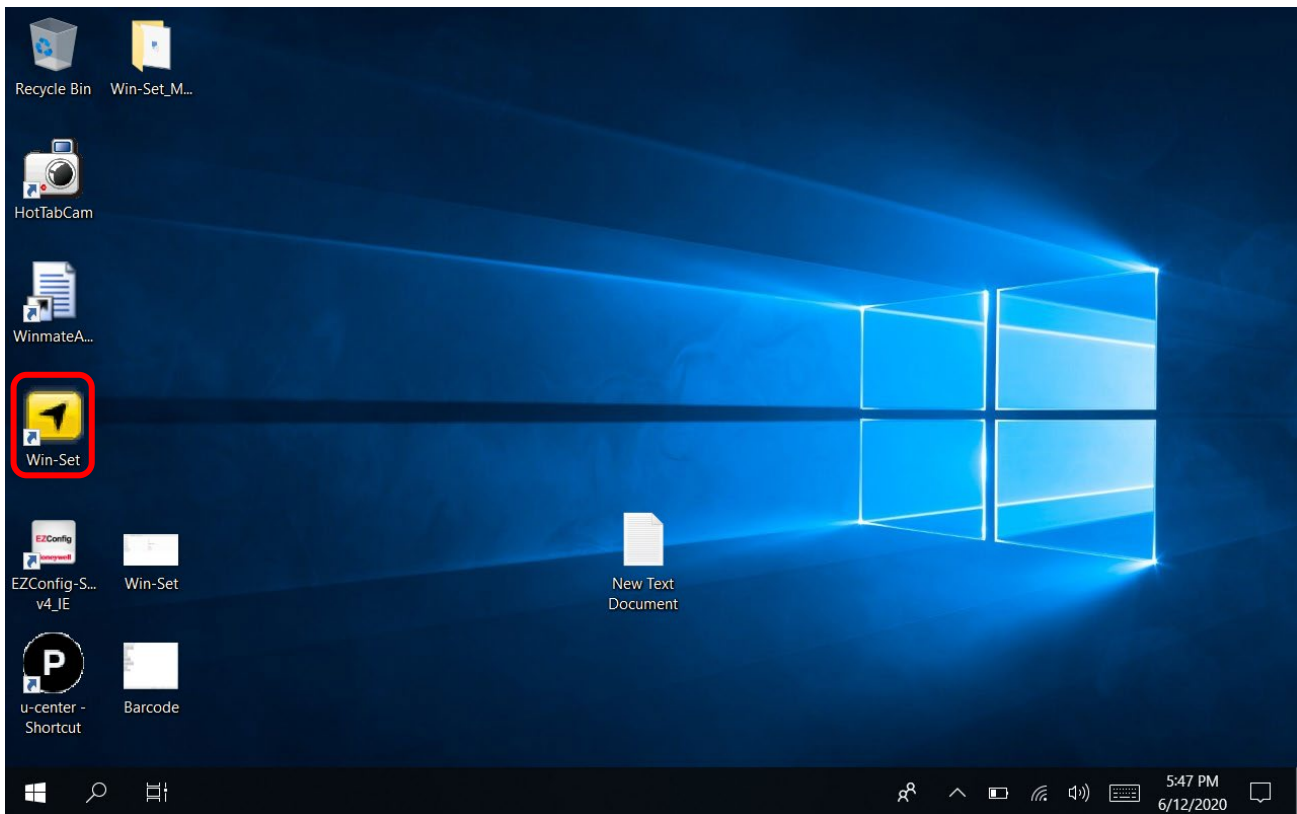

## 7. Barcode Scanner Wedge turns OFF

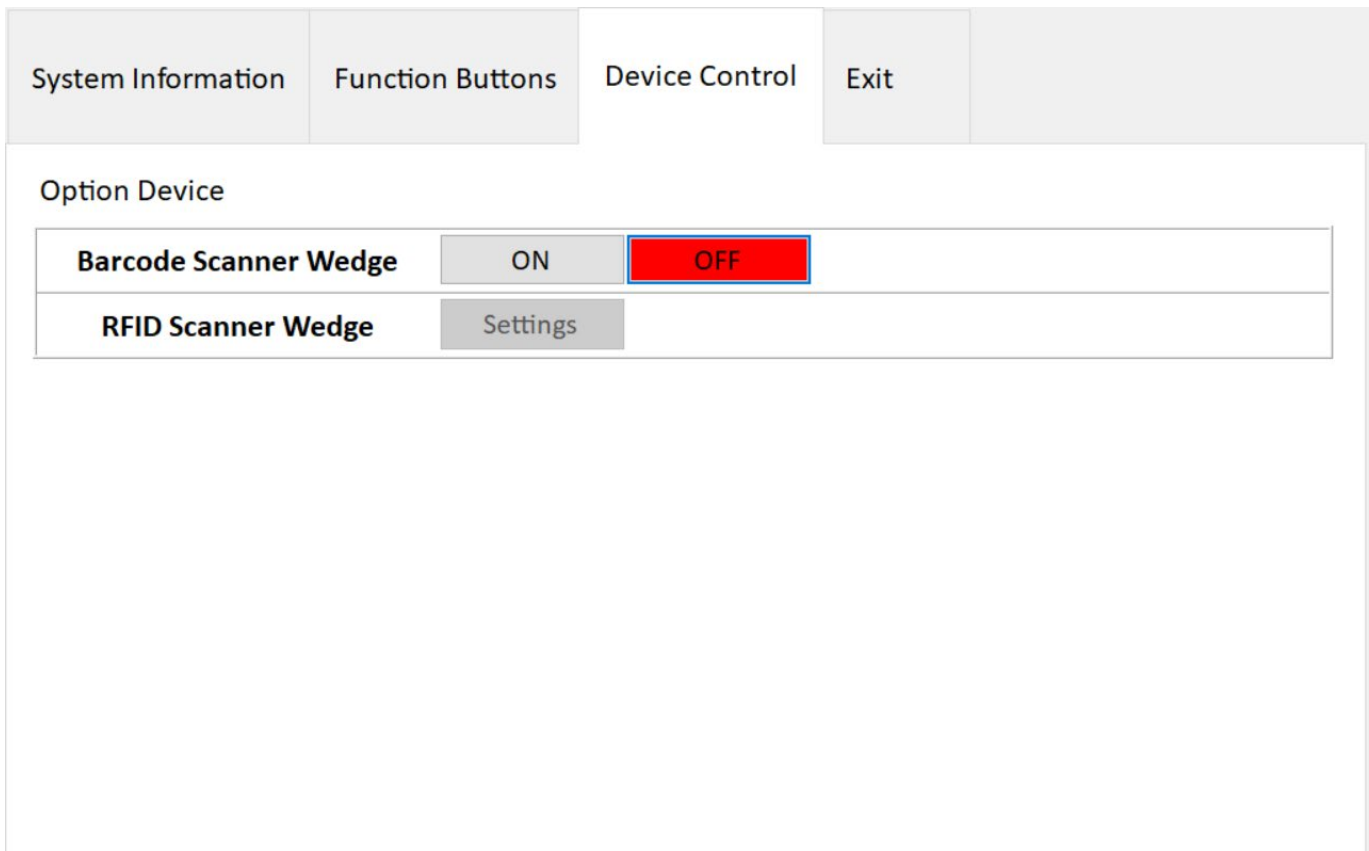

## 8. Barcode Scanner Wedge turns On

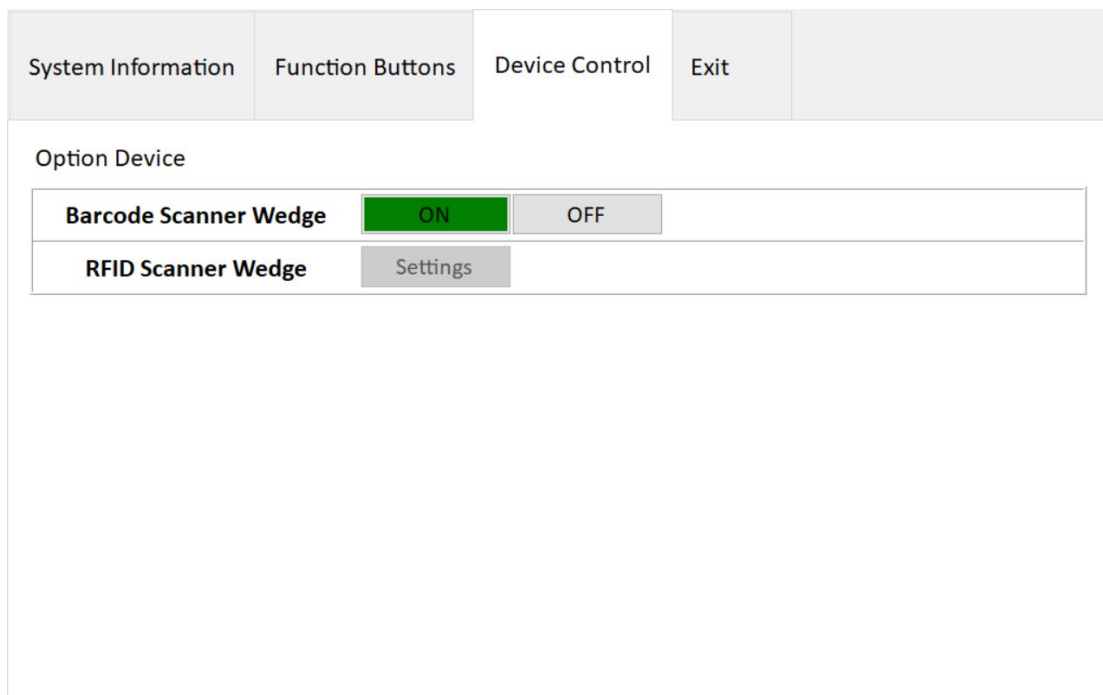

## 9. Scanner Barcode

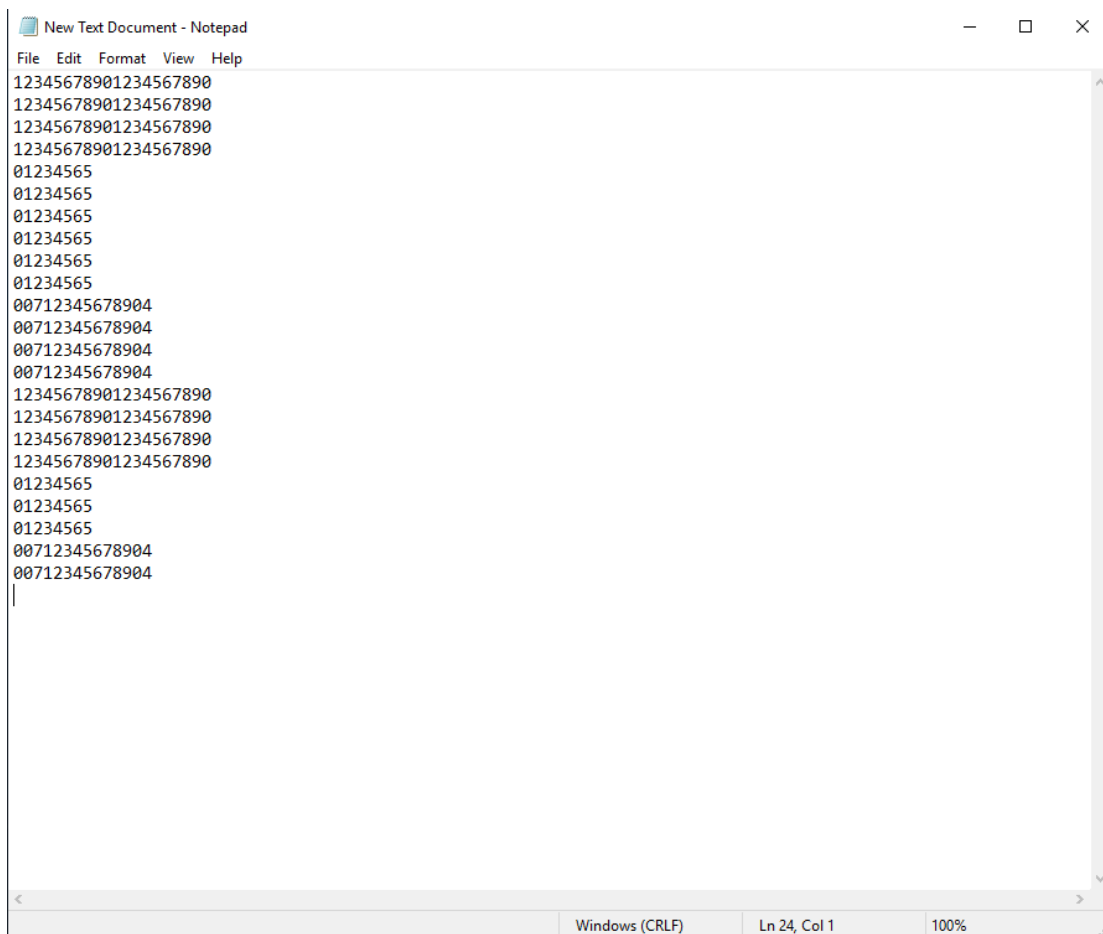

## 4.5 Built-in Devices On/Off

This section describes how to get a quick access to set-up built-in devices, including turning on/off RF modules, setting up barcode reader, and RFID reader.

Hottab Utility .

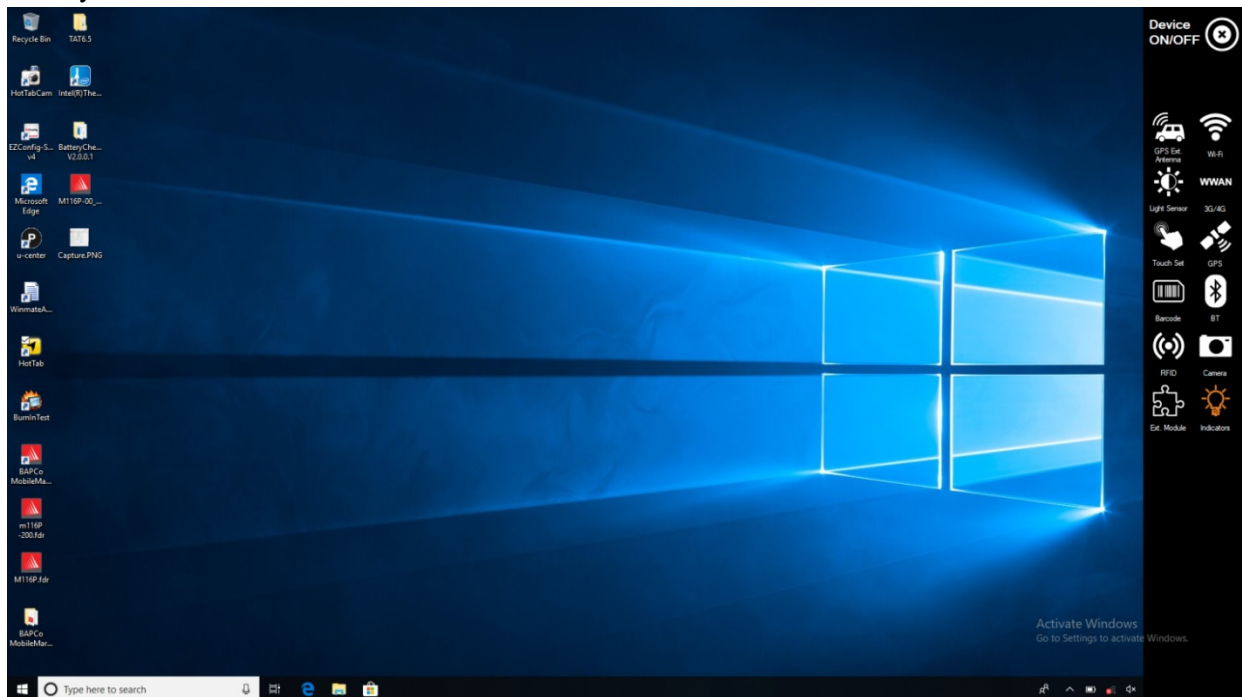

### 4.5.1 Using the Wireless LAN (Wi-Fi)

To use the wireless LAN (Wi-Fi) feature to connect to the network, perform the following procedure:

1. Launch the Hottab Utility .
2. Tap on the **Device ON/OFF** button.
3. Check the status color of the **Wi-Fi** icon:

Item	Status Color	Description
 <b>Wi-Fi</b>	Orange	Wi-Fi is enabled.
	White	Wi-Fi is disabled.

4. If the Wi-Fi feature is disabled (white), tap on the Wi-Fi icon to enable it (orange).
5. Click the wireless network connection status icon in the Windows notification area. A list of available wireless networks is displayed.
6. Double-click a network to connect to it. Provide required authentication information if needed.
7. To check the connection status, observe wireless network connection status icon in the Windows notification area. The more bars the icon shows, the better the wireless LAN connection strength is.
8. Now wireless LAN connection is setup, try connection to the network with a internet browser such as Internet Explorer.

### 4.5.2 Using the Wireless WAN (4G LTE)

The Tablet Computer supports data connection with 3G/LTE modules and fits Micro-SIM card. (**Note:** 4G LTE feature is optional). Please follow the procedure described in the previous sections to install 4G LTE module and SIM-card before using this feature.

To connect to the network using wireless WAN:

1. Launch the Hottab Utility .
2. Tap on the **Device ON/OFF** button.
3. Check the status color of the **WWAN** icon:

Item	Status Color	Description
<b>WWAN</b> 3G/4G	Orange	WWAN (3G/ 4G) is enabled.
	White	WWAN (3G/ 4G) is disabled.

4. If the WWAN feature is disabled (white), tap on the WWAN icon to enable it (orange).
5. You can check the wireless WAN connection status through the wireless network connection status icon in the Windows notification area. The more bars encompassed, the better the signal.

### 4.5.3 Using the GPS

To enable the GPS:

1. Launch the Hottab Utility .
2. Tap on the **Device ON/OFF** button.
3. Check the status color of the **GPS** icon:

Item	Status Color	Description
 <b>GPS</b>	Orange	GPS is enabled.
	White	GPS is disabled.

4. If the GPS feature is disabled (white), tap on the GPS icon to enable it (orange).
5. Now the GPS feature is ready to be used with an application utilizing the GPS.

### 4.5.4 Turn on/off the GPS External Antenna

The vehicle dock of M116K Tablet PC supports external GPS antenna through standard SMA connector. To work with external GPS antenna, please make sure the tablet PC is well installed to vehicle dock, and the vehicle dock has connected with external GPS antenna.

When working with vehicle dock connecting to external antenna, user can switch GPS antenna from the internal one to the external one from Hottab menu.

To enable/ disable the GPS Ext. Antenna:

1. Launch the Hottab Utility .
2. Tap on the **Device ON/OFF** button.
3. Check the status color of the **GPS Ext. Antenna** icon:

Item	Status Color	Description
 <b>GPS Ext. Antenna</b>	Orange	GPS Ext. Antenna is enabled, and using external antenna if available
	White	GPS Ext. Antenna is disabled, and using built-in antenna

4. If the GPS Ext. Antenna is disabled (white), tap on the GPS Ext. Antenna icon to enable it (orange).

### 4.5.5 Using the Bluetooth

To enable the Bluetooth:

1. Launch the Hottab Utility .
2. Tap on the **Device ON/OFF** button.
3. Check the status color of the **Bluetooth** icon:

Item	Status Color	Description
 <b>BT</b>	Orange	Bluetooth is enabled.
	White	Bluetooth is disabled.

4. If the Bluetooth feature is disabled (white), tap on the Bluetooth icon to enable it (orange).
5. Click the Bluetooth icon in the Windows notification area. A contextual menu for Bluetooth is displayed.
6. To add a device, tap on *Add a Bluetooth Device*. Windows will search any Bluetooth device automatically.
7. Choose the Bluetooth device to connect and follow onscreen prompt to continue the pair procedure and use the Bluetooth device.

### 4.5.6 Turning On/Off LED Indicators

The LED Indicators for Power Status, Battery Status, and RF Communication can be turned on/off from Hottab menu.

To enable/disable the LED indicators:

1. Launch the Hottab Utility .
2. Tap on the **Device ON/OFF** button.
3. Check the status color of the **Indicator** icon:

Item	Status Color	Description
 <b>Indicator</b>	Orange	LED indicator is enabled.
	White	LED indicator is disabled.

4. If the indicator is disabled (white), tap on the Indicator icon to enable it (orange).

## 4.5.7 Using the Barcode Reader

The 2D/1D Barcode Reader is optional for M116K Tablet PC and is not re-workable by the end user. To use this feature, please make sure the tablet PC is built-in barcode reader before use, or contact our sales contact window for more details.



**Note:**

Download the SDK from Winmate Download center [here](#).  
>> M116K >> Development Kit or check the Driver CD which is shipped with the Tablet.

To enable the Barcode Reader:

1. Launch the Hottab Utility .
2. Tap on the **Device ON/OFF** button.
3. Check the status color of the **Barcode** icon.

Item	Status Color	Description
 <b>Barcode</b>	Orange	Barcode Reader is enabled. Reading will need to be triggered manually thru function button.
	White	Barcode Reader is disabled.

4. Open the application where barcode reader will be displaying the scanned barcode.
5. Trigger the barcode reader by pressing F2 function key (function key is programmable and can vary based on your settings).

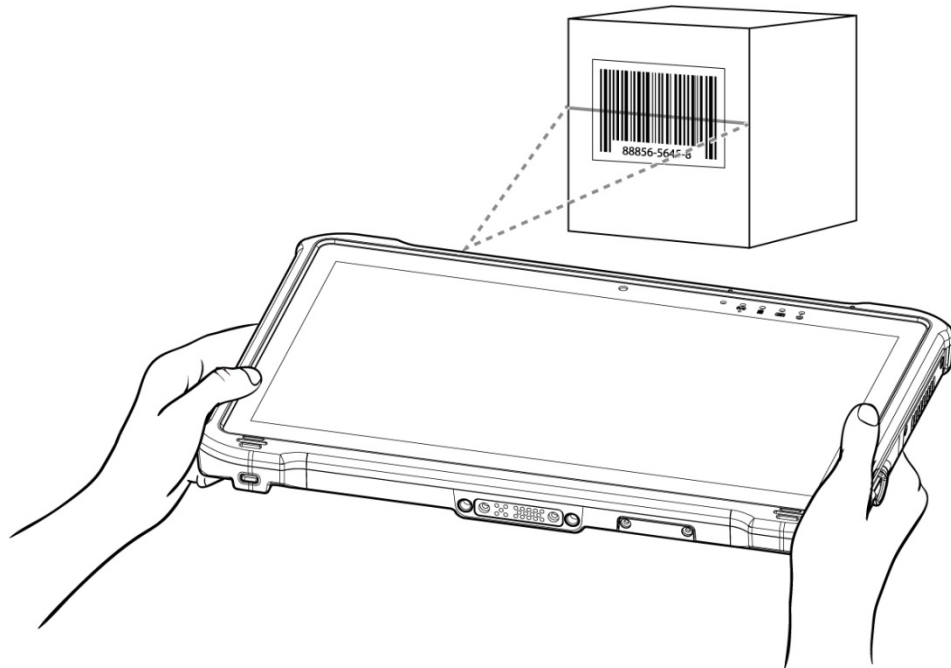

Tap **Disconnect** button to stop the connection with Barcode Reader.

*\*To recover the connection, please tap on the button again to re-connect with Barcode Reader.*



### 4.5.7.1 Device Configuring and Setting

1. Click on Windows  and search for **EZConfig-Scanning** from the Start menu.

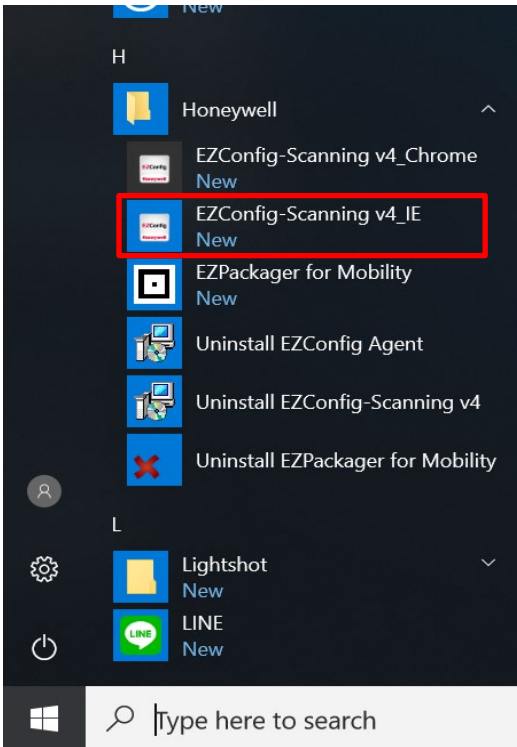

2. Click on **EZConfig-Scanning v4\_IE** and allow the blocked content if browser is blocking the content.

3. Click on “Connected Device” icon and wait for system to discover the device (Honeywell N660X).

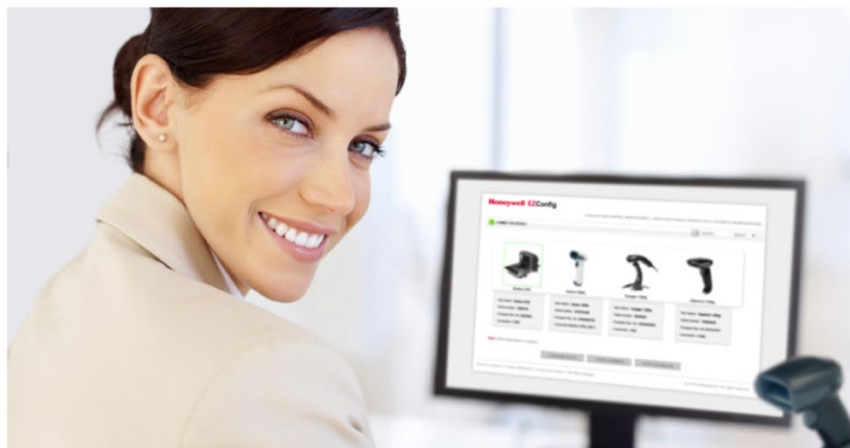
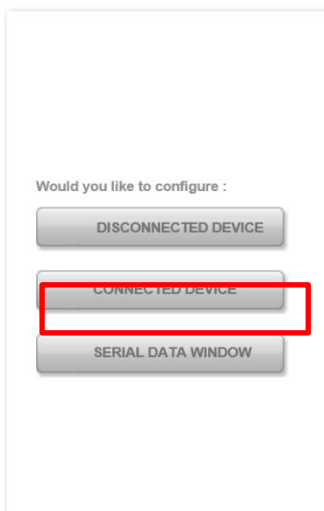

EZConfig-Scanning provides a wide range of programming functions that can be performed on a Honeywell scanning device connected to a computer. EZConfig-Scanning allows you to change programmed parameters, create and print programming bar codes and update device firmware.

Internet Explorer restricted this webpage from running scripts or ActiveX controls.

Allow blocked content ×

4. Once Honeywell N660X is discovered please click **“Configure Device”** button as shown.

GETTING STARTED | NEW FEATURES | CHECK FOR EZConfig UPDATES | FAQ | HELP | TECHNICAL KNOWLEDGE BASE

**CONNECTED DEVICE**

Home ▶ Connected Device

Refresh



**Honeywell N660X Series  
Area Image Engine**

Model: **N660X**

Serial No: **18036B086F**

Firmware No: **BI000858HAC**

Connection: **USB HID KBD**

[Show License/Plug-in Info](#)

Firmware is up to date

**Note:** Click on the device to connect / disconnect

CONFIGURE DEVICE

UPDATE FIRMWARE

SCAN DATA WINDOW

#### 4.5.7.2 Scanning Mode Settings

1. Click **Device Settings** under the Input/Output settings section.

Honeywell N660X Series Area Image Engine

**1.SETTINGS**

**2.SYMBOLOGIES**

**3.DATA FORMATTING**

**4.IMAGING**

**5.SCAN DATA WINDOW**

**6.COMPARE**

Input/Output Settings | Interfaces | Licenses / Plug-ins (Apps) |

Beeper Settings | Scanning Options | Device Settings |

2. Select the desire scanning mode from the drop-down menu shown as below.

#### Scanning Mode Modifiers

Scanning Mode Default: 0

Host Notify Mode  
 Manual Trigger  
 Presentation Mode  
 Snap And Ship Mode  
 Streaming Presentation(TM) Mode

Presentation LED Behavior After Decode

Presentation Sensitivity  Range: 0-20 Default: 1

Presentation Mode Pre Aimer Delay **Off**  **On**  Default: 1

TRGMMF  Default: 0

Trigger Pre Aimer Delay  Range: 0-9999 Default: 0

TRGOTO  Range: 0-9999 Default: 2500

3. After selecting a desired scanning mode, click on the “**Save to Device**” on the side bar.



Scanning Mode	Description
<b>Manual Trigger</b>	When in manual trigger mode, the scanner scans until a bar code is read, or until the trigger is released. Two modes are available, <b>Normal</b> and <b>Enhanced</b> . Normal mode offers good scan speed and the longest working ranges (depth of field). Enhanced mode will give you the highest possible scan speed but slightly less range than Normal mode. Enhanced mode is best used when you require a very fast speed and don't require a long working range. Default = Manual Trigger-Normal.
<b>Presentation Mode</b>	Presentation Mode uses ambient light and scan engine illumination to detect bar codes. When in Presentation Mode, the LEDs remain dim until a bar code is presented to the scan engine, then the aimer turns on and the LEDs turn up to read the code. If the light level in the room is not high enough, Presentation Mode may not work properly.
<b>Streaming Presentation Mode</b>	When in Streaming Presentation mode, the scan engine's aimer goes out after a short time, but the scan illumination remains on all the time to continuously search for bar codes. Two modes are available, <b>Normal</b> and <b>Enhanced</b> . Normal mode offers good scan speed and the longest working ranges (depth of field). Enhanced mode will give you the highest possible scan speed but slightly less range than Normal mode. Enhanced mode is best used when you require a very fast scan speed and don't require a long working range.
<b>Host Notify Mode</b>	Host Notify Mode bypasses the decoder and notifies the host that there has been a hardware trigger pull. When in Host Notify Mode, it is up to the host to initiate an Image Snap and/or an Image Ship command. It is also up to the host to switch to another trigger mode.
<b>Snap and Ship Mode</b>	Snap and Ship mode, allows you to bypass the decoder and ship an image directly to the host. In this mode, an image is taken and shipped upon each trigger pull, instead of being sent to the decoder. Snap and Ship is useful when you are using your own decoder.

### 4.5.7.3 Setting the 1D/2D Barcode Scanner Symbolologies

The barcode scanner is shipped with default settings shown below. If the default setting suits the usage requirement, setting symbolologies is not necessary.

#### Symbolologies Default Settings:

	Symbolologies	Default
Linear	UPC-A	Enable
	UPC-E	Enable
	EAN/JAN-8	Enable
	EAN/JAN-13	Enable
	UPC-E1	Disable
	UPC-A/EAN-13 Extended Coupon Code	Disable
	GS1 DataBar Omni-Directinal	Enable
	GS1 DataBar Limited	Enable
	GS1 DataBar Expanded	Enable
	Code 39	Enable
	Code 128	Enable
	ISBT 128	Disable
	GS1-128	Enable
	Interleaved 2 of 5	Enable
	Matrix 2 of 5	Disable
	NEC 2/5	Enable
	IATA 2/5	Disable
	Code 2/5	Disable
	Codabar	Enable
	Code 93	Enable
	Code 11	Disable
	MSI	Disable
	Telepen	Disable
	Trioptic Code	Disable
	Postal Code	Disable
	Planet Code	Disable
	Korea Psot	Disable
	China Post	Disable
	Australian Post	Disable
	2D	Data Matrix
PDF 417		Enable
Micro PDF 417		Enable
Codablock A		Disable
Codablock F		Disable
Maxicode		Disable
QR Code		Enable
Aztec		Enable
Composite Code		Disable
Han Xin		Disable

Changing default setting of symbolologies or the advanced setting

There are two methods to change the default setting of symbolologies or other advanced setting:



**Method (1).** Click on the Symbolologies  on the top, then you can change the symbology to the default setting or make advanced setting by its category. After setting, click on the “Save to Device” on the side bar.

**Method (2).** Click on the reset to default button on the side as shown blow:



### Important:

1. The reset to default button will change all setting to default.
2. N660X could disconnect with system after clicking the reset to default button. If the Disconnection happened please scan barcodes below in the following steps.

Step1. Scan the USB HID barcode:

#### **USB HID**

Scan the following code to program the scan engine for USB HID.



Step 2. Then scan the USB keyboard barcode:

#### **USB PC or Macintosh Keyboard**

Scan one of the following codes to program the scan engine for USB PC Keyboard or USB Macintosh Keyboard. Scanning these codes also adds a CR suffix.



Step 3. Run **EZConfig-Scanning** again by following **4.4.6.1 Device Configuring and Setting**

### 4.5.7.4 Adding a Prefix or Suffix

1. To add a Prefix or Suffix please click on “Data Formatting icon”.

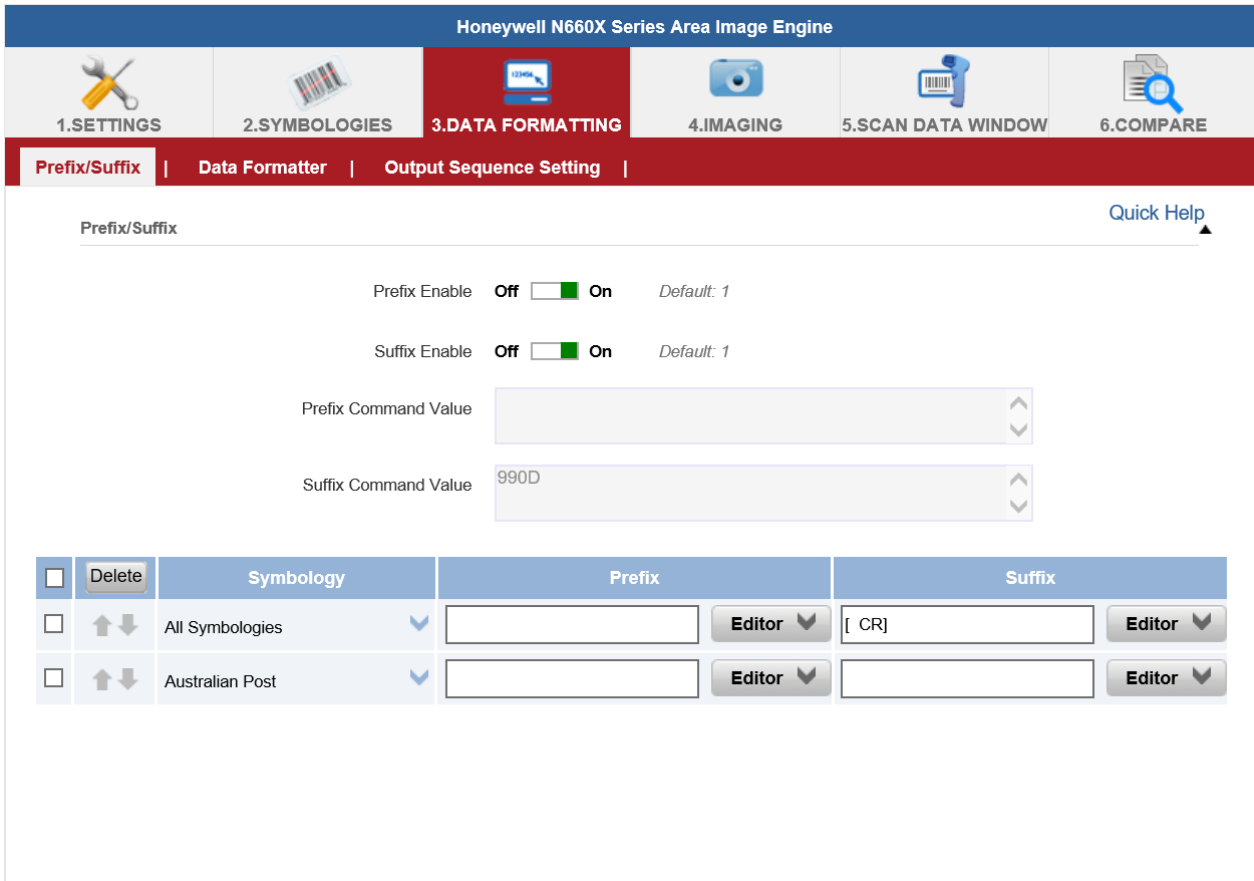

2. Click on Editor button under the Prefix or Suffix section and create Prefix/Suffix value by typing in the block or select desire characters in the Control chars, Printable chars, and Extended ASCII. as shown below:

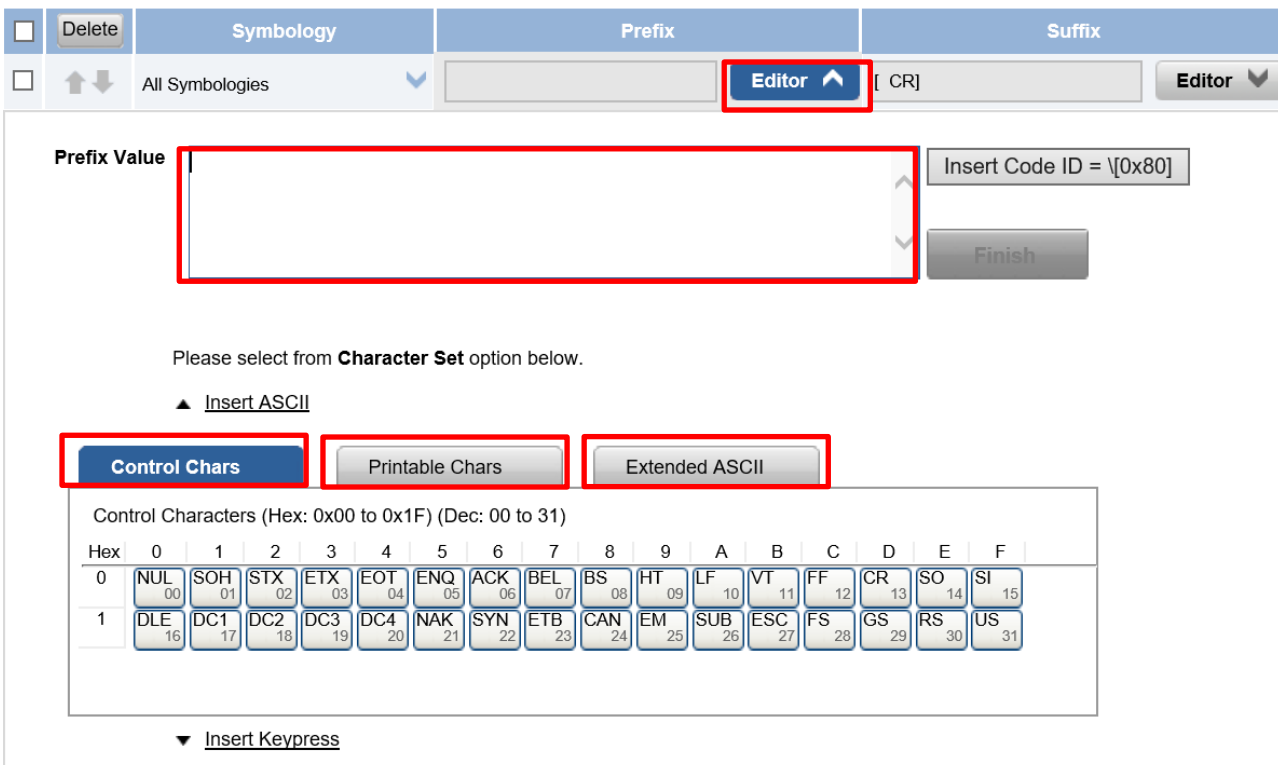

- When you finish creating Prefix/Suffix, please click on **“Save to Device”** on the side bar.



- For checking the functionality of Prefix/Suffix, please click on **“Scan Data Window”** icon on the top. Then scan a barcode to verify if the Prefix/Suffix appear correctly.

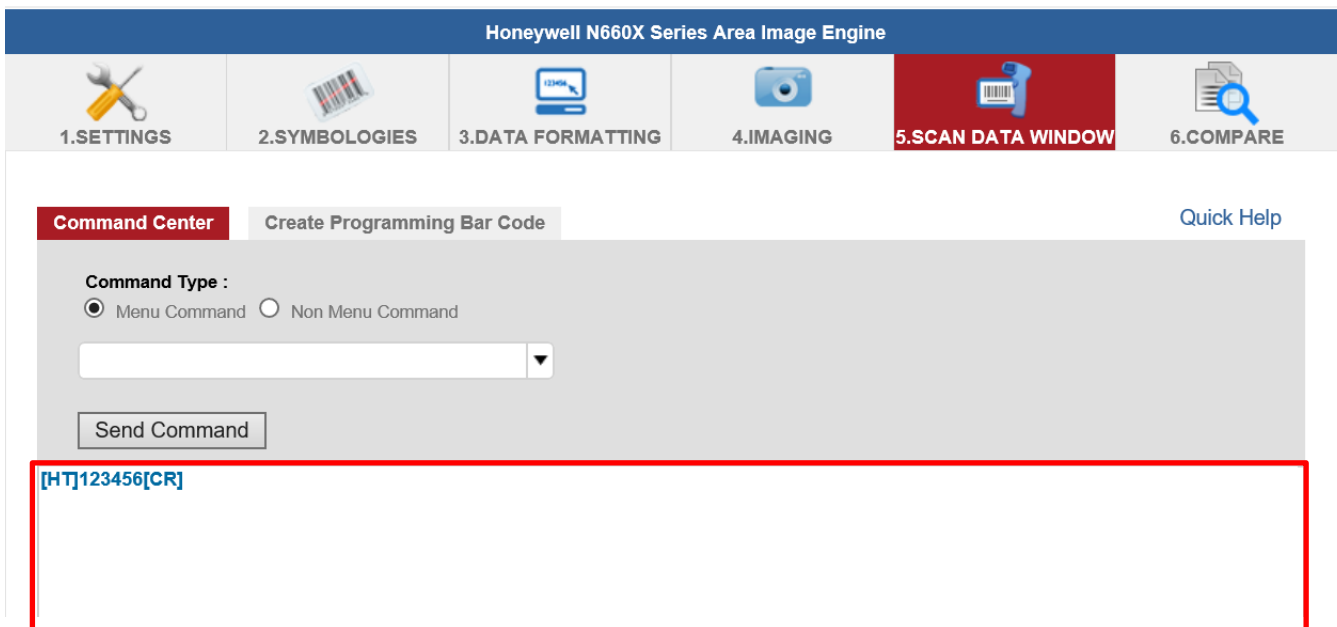

## 4.5.8 Using the HF RFID Reader

The HF RFID Reader is optional for M116K Tablet PC and is not re-workable by the end user. To use this feature, please make sure the tablet PC is built-in HF RFID reader before use, or contact our sales contact window for more details.

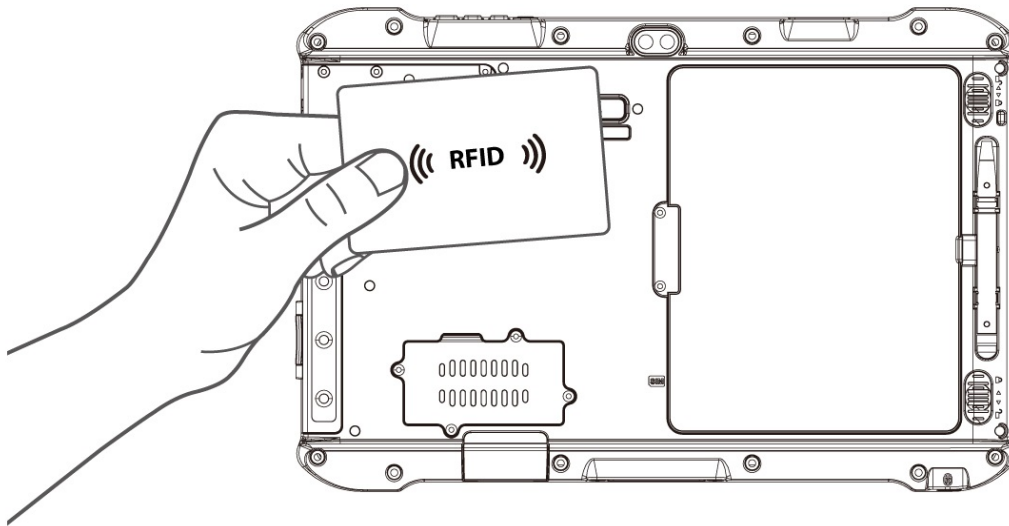

To enable the HF RFID Reader feature:

1. Launch the Hottab Utility .
2. Tap on the **Device ON/OFF** button.
3. Tap on **RFID**, and the setting utility will show up as below:

4. Tap on the **ON** button.
5. Check the status color of the ON icon is green, and the status color of the RFID icon on the Hottab menu is orange at the same time.

Item	Status Color	Description
 <b>RFID</b>	Orange	HF RFID Reader is enabled.
	White	HF RFID Reader is disabled.



#### 4.5.8.1 RFID Trigger Setting

**Auto Scan** The default setting for RFID trigger is Auto Scan. Under this setting, the RFID Reader will always be ready to scan tags.

1. When the RFID tag is detected from RFID antenna, the data will be read automatically.
2. User can define the RFID scanning frequency from the drop-down menu shown as below. The frequency can be from 1 second to 9 seconds.

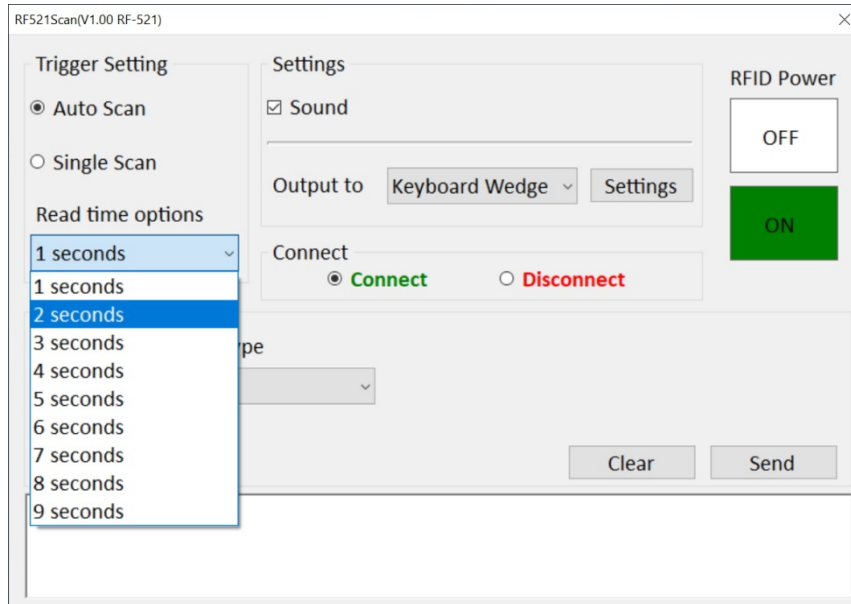

#### Single Scan

User can also define the RFID Reader scanning as **Single Scan**. Under this setting, the RFID Reader will be triggered only when user click “**Send**”.

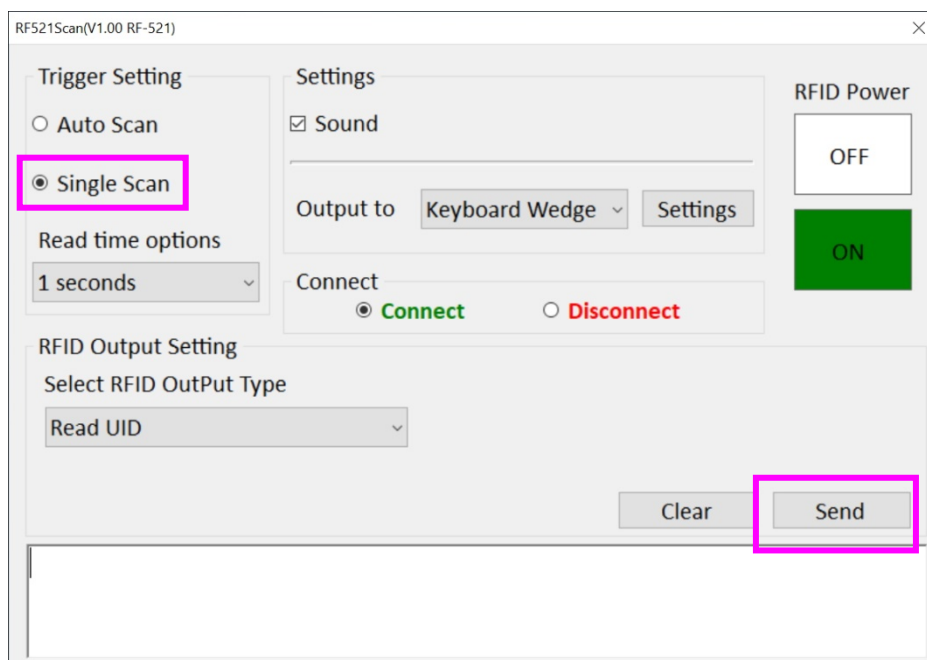

### 4.5.8.2 Settings

**Sound** The **Sound** check box defines whether a beep sound will come with the data scanning.

**Output to** This setting defines the output type of the scanned data. Two options are available:

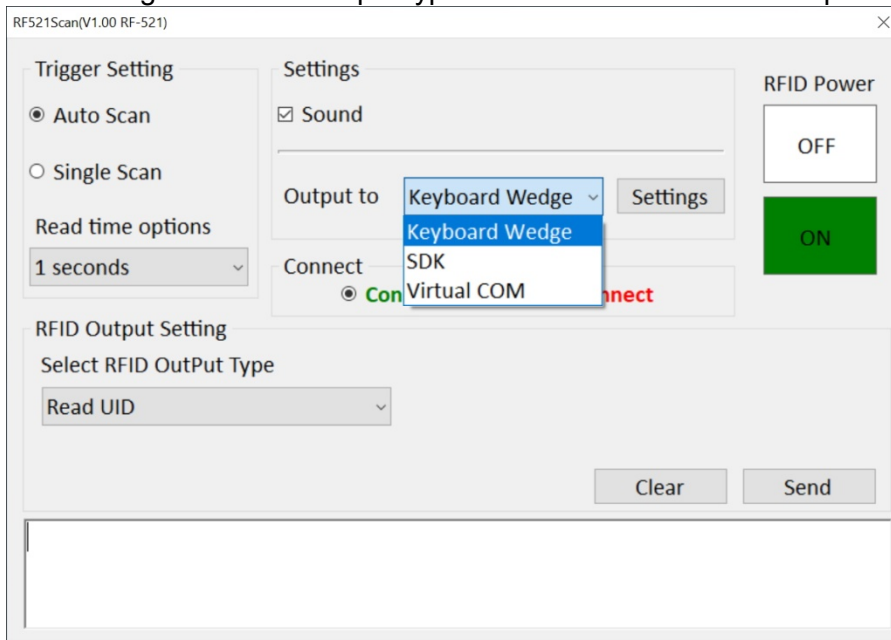

#### Keyboard Wedge

Under this setting, the data scanned is sent like keyboard data. The scanned data can be output directly to the demo area below this window, or user can also open other utility, such as Office Word or Notepad files, for data input.

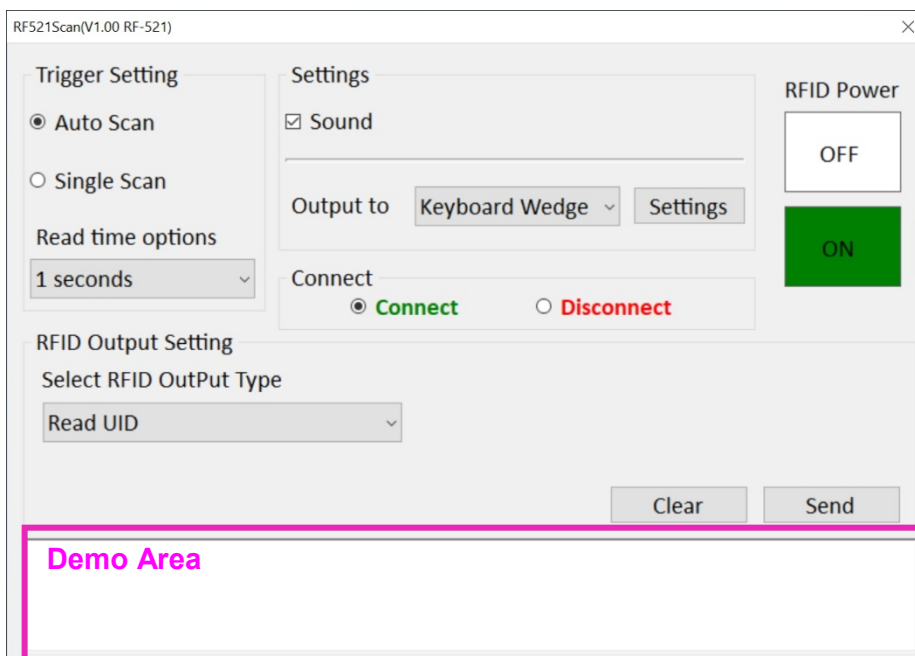

**Note:** notice that the input method should support the scanned character. User can also tap on the **Settings** button for further details settings.

Item	Description
Prefix	User can type in this field to define the characters BEFORE the data scanned.
Suffix	User can type in this field to define the characters AFTER the data scanned.
Append Enter	The check box user can defines to append an “Enter” which is followed by the characters.
Append TAB	The check box user can defines to append an “TAB” which is followed by the characters.
Regex Filter	Press on “Presets...” button, user can define how many characters to show after the data scanned. <div data-bbox="619 1115 1353 1630" data-label="Form"> </div>
Replace	User can define specific characters to be replaced with preferred characters automatically. When the characters defined in <b>Regex Substitution</b> is scanned, the data will be replaced with the one filled in <b>Replace with</b> .
Reset to default	User can remove all the set up and back to default mode.

### SDK

For users following SDK for software porting, the scanned data can also be output with the format needed.



**Note:**

User can download the SDK from Winmate Download center website >> M116K >> Development Kit or check the Driver CD which is shipped with the Tablet.

**4.5.8.3 RFID Output Setting**

**Select RFID Output Type**

The default setting for built-in HF RFID Reader is to **Read UID**. For some applications, user might need to read or write further block data; the drop-down menu under this section can do this change.

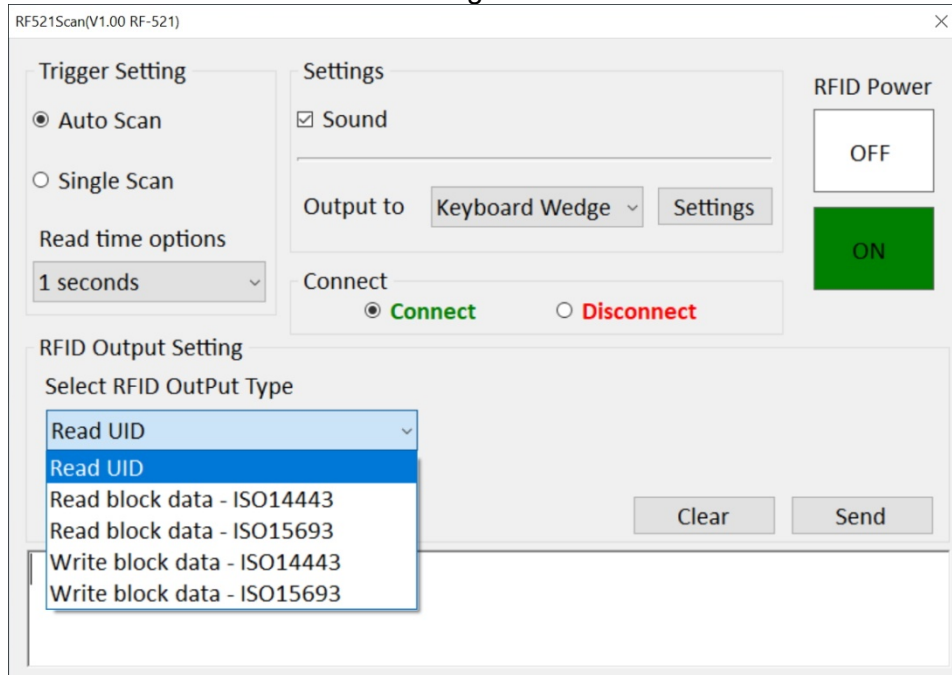



**Disconnect** User can tap on the **Disconnect** button to stop the connection with built-in HF RFID reader.

\* To recover the connection, please turn off the module from setting UI and then turn on the module again.

**4.5.9 Turn on/off the Light Sensor**



The Light Sensor can be turned on/off from Hottab menu. To enable/disable the Light Sensor, perform the following procedure:

1. Launch the Hottab Utility .
2. Tap on the **Device ON/OFF** button.
3. Check the status color of the **Light Sensor** icon:

Item	Status Color	Description
 <b>Light Sensor</b>	Orange	Light Sensor is enabled.
	White	Light Sensor is disabled.

## 4.5.10 Changing Touchscreen Modes

The Tablet Computer supports three built-in operating modes for different usage scenarios:

Mode	Description
 <p>Hand/Rain (Default)</p>	<p>In <i>Hand/Rain</i> mode the touchscreen rejects false inputs from liquid drops. When the liquid is removed, the touchscreen accepts touch inputs from bare fingertips.</p> <p><i>Supports input by:</i></p> <ul style="list-style-type: none"> <li>• <i>Rubber tip passive stylus</i></li> <li>• <i>Bare fingertips</i></li> </ul>
 <p>Stylus</p>	<p>In <i>Stylus</i> mode, the touchscreen supports inputs from the fine-tip passive capacitive stylus (shipped with Tablet).</p> <p><i>Support input by:</i></p> <ul style="list-style-type: none"> <li>• <i>Fine-tip passive stylus with palm rejection</i></li> <li>• <i>Rubber tip passive stylus</i></li> <li>• <i>Bare fingertips</i></li> </ul>
 <p>Glove</p>	<p>In <i>Glove</i> mode, the touchscreen supports inputs while the user is operating the touchscreen with gloves on.</p> <p><i>Supports input by:</i></p> <ul style="list-style-type: none"> <li>• <i>Glove</i></li> <li>• <i>Rubber tip passive stylus</i></li> <li>• <i>Bare fingertips</i></li> </ul>

To change touch mode:

Launch the Hottab Utility . Choose “**Device ON/OFF**”, and then click “**Touch Set**” icon.  →  → 

#### 4.5.10.1 Switch via Built-in HotTab Utility

To switch touchscreen mode via the HotTab:

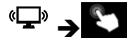
1. Launch the Hottab Utility .
2. Choose “**Device ON/OFF**” and then click on “**Touch Set**” icon .
3. Under the “**Touch Mode**”, select the desired touch modes by tapping on the radio button.
4. Here’s also additional Touch related setting to switch the touchscreen input between mouse mode with cursor, or with multi-touch mode:  
*Mouse Mode*: Single touch point supported, with mouse cursor shown.  
*Multi-touch Mode*: The default setting of the touch screen supports multi-touch mode (up to 10 points)

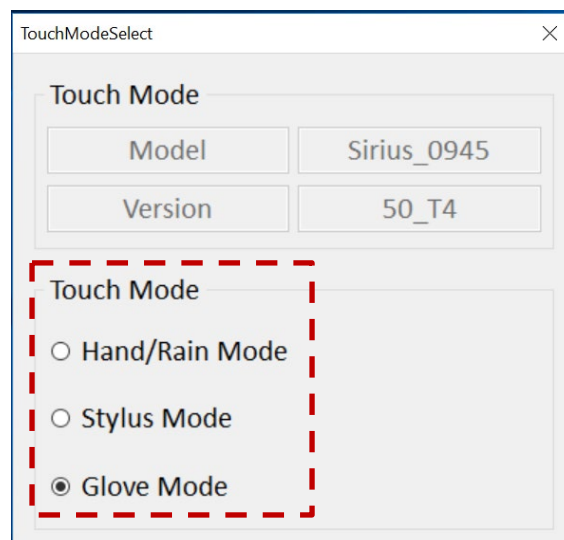

#### 4.5.10.2 Switch via Programmable Function Buttons:

To switch between the different touchscreen modes via the programmable function buttons, make sure the touchscreen mode switching is set to the programmable function buttons first.

1. Launch the Hottab Utility .
2. Tap on the **Setting** button.
3. Tap on **F1** icon.
4. Tap on the **Long Press** icon.
5. Change the Long Press function to “**Touch Mode**” as shown below:

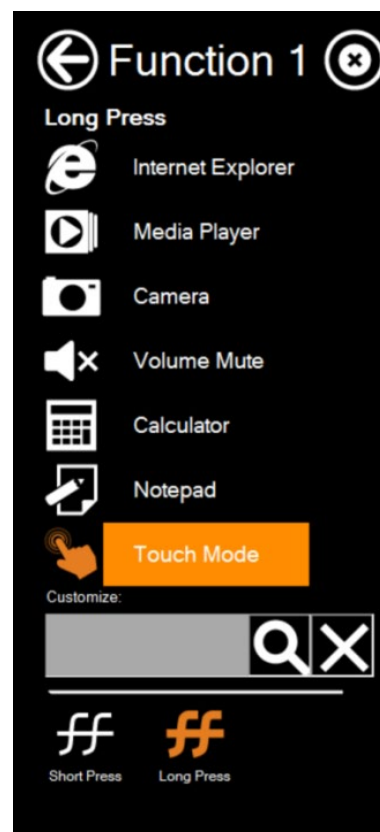

Once the touchscreen mode switching is set to the programmable function button, **Long Press** on “**F1**” function button to cycle through the different touchscreen modes. When touchscreen mode is switched, an icon will temporarily overlay on the lower center of the screen to indicate current touchscreen mode:

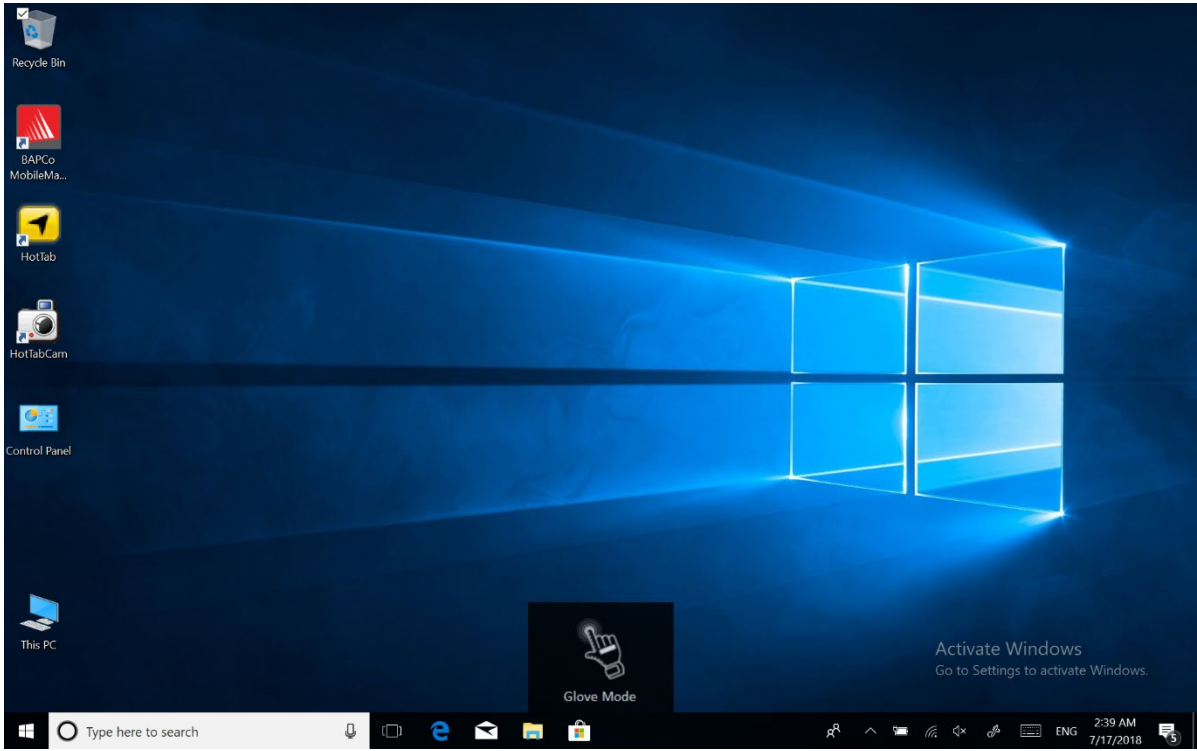

## Chapter 5: Frequently Used Settings

### 5.1 Screen Resolution Scaling and Setting

The M116K rugged Tablet's 1920 x 1080 Full HD high resolution display is perfect for viewing image, video, or other applications; however, Windows user interface (icons, buttons, and other user interface elements) may be too small to read and operate at the default Windows settings. By changing the display scaling or the display resolution setting of the device, you can adjust the size of the text and other items on the desktop for optimal viewing. Display scaling is the recommended method because it has the effect of adjusting user interface element without having to move away from the optimal resolution setting at 1920 x 1200. This section will explain how you can adjust the built-in windows display scaling setting and resolution setting.



#### Note:

- The Tablet Computer is shipped with display scaling set at **Larger - 150%**. We recommend the users set the scaling to this setting for optimal text and image viewing.
- Before proceeding to change the scaling option, make sure any opened document is saved and close, and all running applications are closed before proceeding to change the display scaling, because this procedure requires users to log out of their account to apply display scaling change.

#### 5.1.1 Changing Display Scaling (Recommended)

Perform the following to change display scaling setting:

1. Tap and hold anywhere on the desktop for 3 seconds and release to bring up the context menu, and select "Display settings" option as shown below:

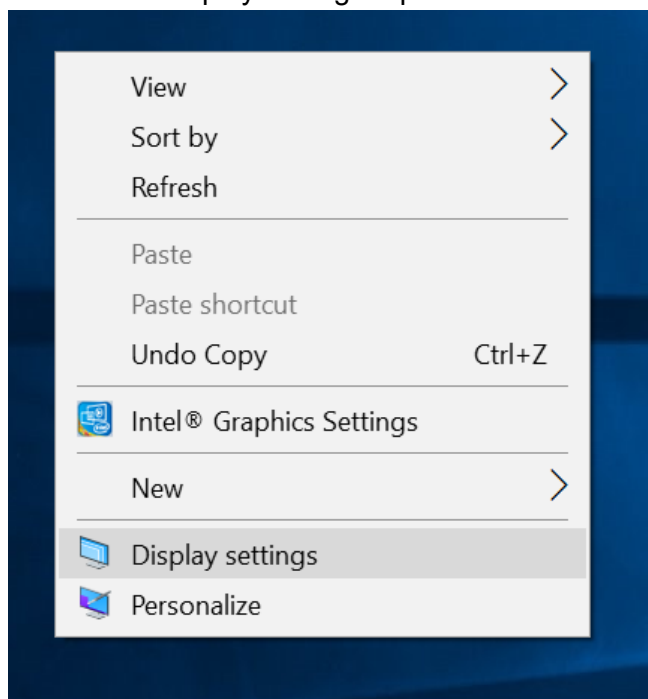

2. A "Display" Window will show up. Click on the dropdown option under the "Scale and layout" section and change the scaling option to "**150% (Recommended)**" or any other desired display scaling.



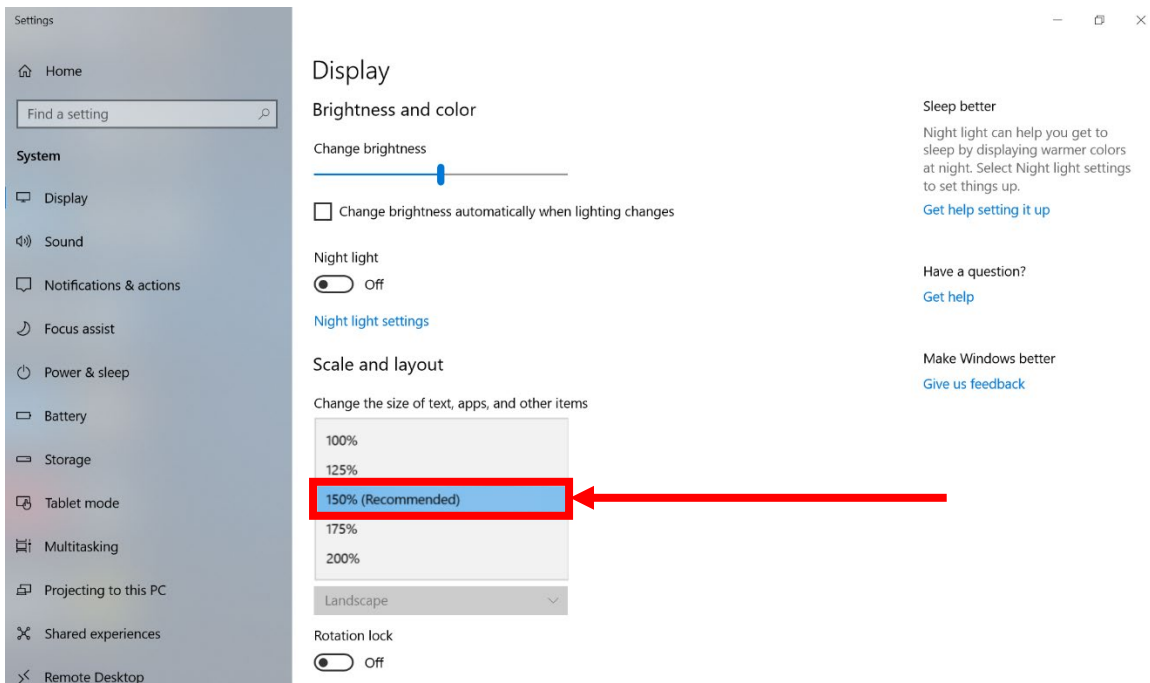

### 5.1.2 Changing Screen Resolution

Alternatively, instead of changing the display scaling setting, user may choose to change the overall resolution setting to make screen elements bigger.

1. Tap and hold anywhere on the desktop for 3 seconds and release to bring up the context menu, and select “**Display settings**” option as shown below:

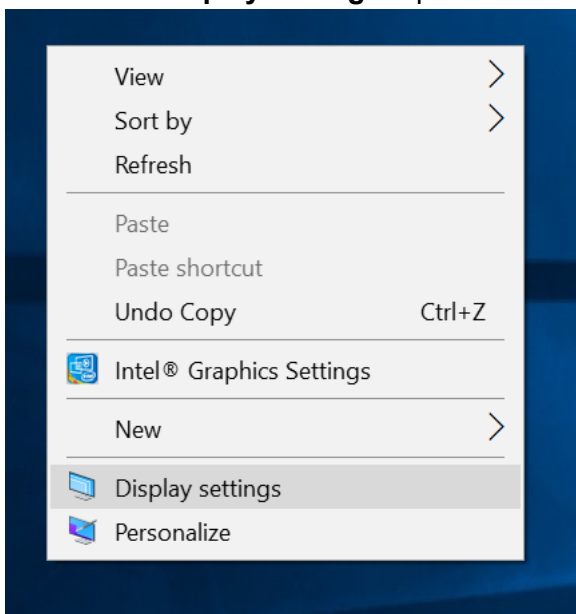

- The native resolution of M116K is **1920 x 1080**. Click on the dropdown option next to “**Resolution**” and select the resolution by tapping on the scale:

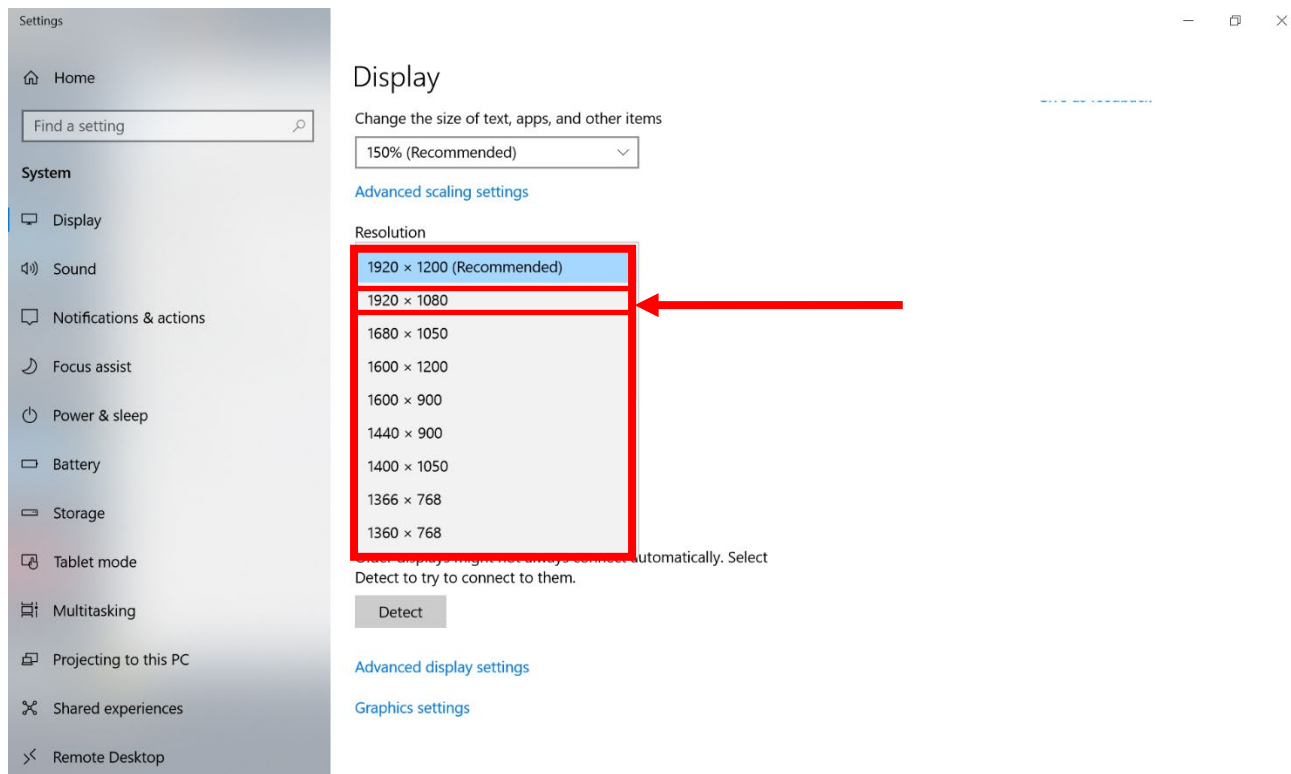

- Hit “**Apply**”. A prompt “**Display Settings**” prompt will show up to ask the user if the applied resolution is usable.
- If the new resolution is the desired display setting hit “**Keep changes**” and continue to next step. If the new resolution is not desirable, hit “**Revert**” and select a different resolution to change to, and start again from Step 2.
- The user may now use the device with the new resolution setting.

## 5.2 Replacing Battery

The M116K Tablet supports hot-swap, meaning the Tablet doesn’t need to be powered off to replace the main battery. To support hotswap, there is a backup battery inside the Tablet that is charged together with the main battery. This battery cannot be removed, and requires adequate power for main battery hot swapping. When the backup battery is fully charged, the Tablet can sustain up to 5 minutes of runtime for battery hot-swapping.



**Caution** Charge the built-in back-up battery every two months to keep battery health and prevent possible issues from battery over-discharge.

**Attention** Chargez la batterie de secours intégrée tous les deux mois pour conserver la santé de la batterie et éviter les problèmes de décharge excessive de la batterie.

*Perform the following to hot swap the batteries:*

- Power on the Tablet, open Hottab to check the power level of the Backup battery.
- If the Backup battery level is “*Low*”, please charge the Tablet with AC Power until the Backup battery level is “*Medium*” or “*High*”, and do not remove the main battery.
- If the Backup battery level is at “*Medium*” or “*High*”, you can remove the main battery.
- Insert a new fully charged battery into the battery compartment.
- Pen Hottab to check Main battery level. If the battery level is displayed incorrect, check if the new removable battery is inserted properly.
- If the battery level displayed correct, continue using the Tablet.

To remove the battery pack:

1. Shut down the Tablet (or put into sleep mode). Turn the Tablet Computer over, back facing up.
2. Push the Battery Lock Latch it to the “Unlocked” position.
3. Pull up and hold the Battery Release Slider that is spring-loaded.
4. Lift the battery out using the opening on the side of battery compartment.

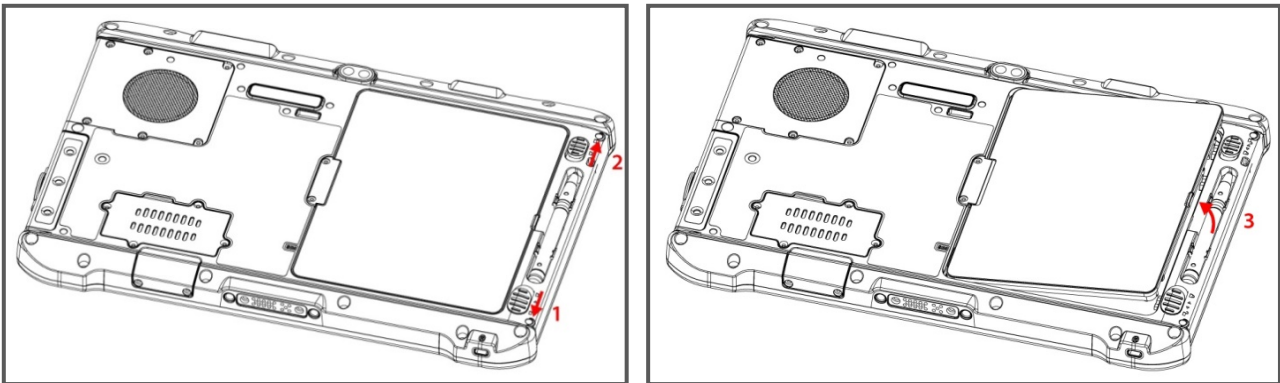

### 5.3 Using Recovery Wizard to Restore Computer

M116K Tablet Computer has a dedicate recovery partition stored on the hard drive of the Tablet to enable quick one-key recovery process. This partition occupies about 11 GB of the storage space, and comes built-in to each M116K Tablet Computer.



**Warning!** Before starting the recovery process, be sure to backup all user data, as all data will be lost after the recovery process.

**Attention!** Avant de démarrer le processus de récupération, assurez-vous de sauvegarder toutes les données utilisateur, car toutes les données seront perdues après le processus de récupération.

Follow the procedure below to enable quick one-key recovery:

1. Plug-in the AC adapter to the Tablet Computer. Make sure the Tablet Computer stays plugged in to power source during the recovery process.
2. Power on the Tablet Computer, and when the boot screen shows up, press the **Fn1** button (Recovery Key) on the front bezel OR press **F6** when using an external USB keyboard to initiate the Recovery Wizard.
3. The following screen shows the Recovery Wizard. Click on “Recovery” button to continue.



4. A warning message about data loss will show up. Make sure data is backed up before recovery, and click on "Yes" to continue.

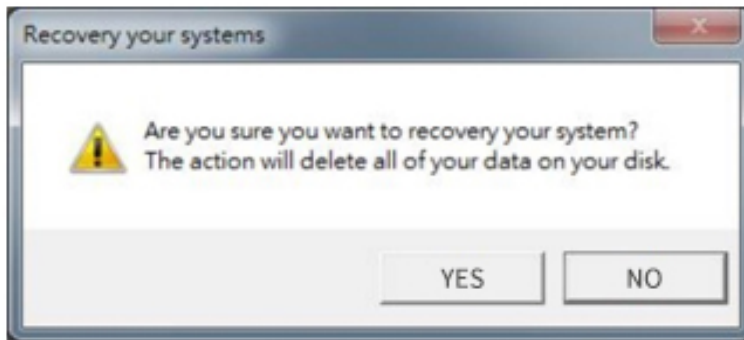

5. Wait till the recovery process to complete. During the recovery process, a command prompt will show up to indicate the percent of recovery process.



6. After recovery is completed, please press any key to continue, and the Tablet Computer will shut down automatically.

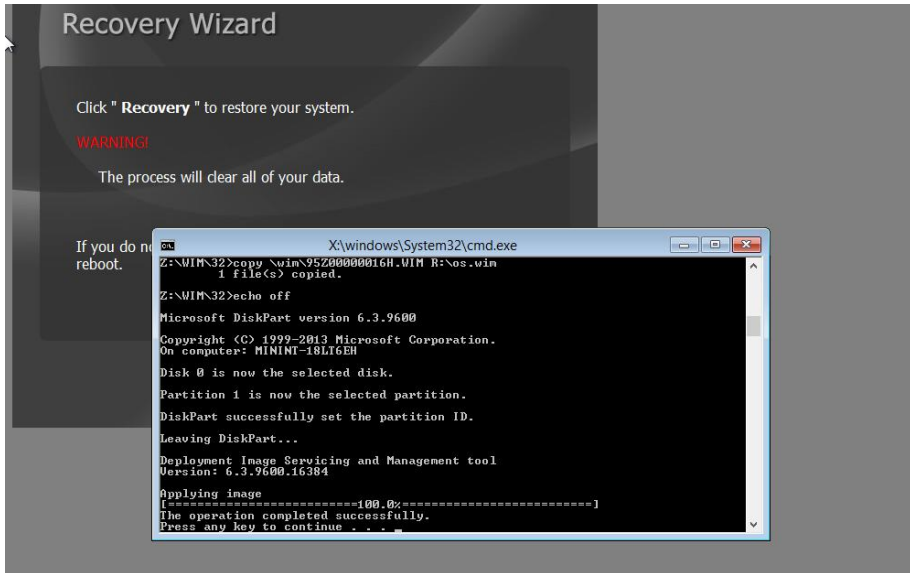

## 5.4 Docking Connector Pin Definition

The M116K Tablet Computer supports one 19-pin docking connector at the bottom side. The pin definition is listed as the following table.

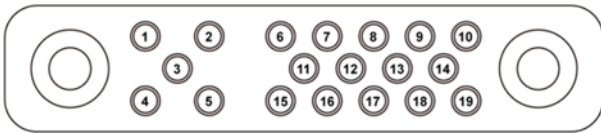

Pin No.	Description	Pin No.	Description
1	RF_GND	11	NC
2	DOCK_DET #	12	NC
3	GPS ANT	13	GND
4	RF_GND	14	Power
5	RF_GND	15	USB+
6	NC	16	USB-
7	NC	17	GND
8	DETECT+	18	GND
9	Power	19	DETECT-
10	Power		

## 5.5 COM Port Definition

The M116K Tablet Computer uses Hottab utility for built-in peripherals control. All the COM port numbers have been defined in the OS image coming with the package.

COM Port	Device
COM 1	Reserved
COM 2	Reserved
COM 3	HF RFID (Optional)
COM 4	Bluetooth Auto Pairing
COM 9	GPS
COM 11	RS232 at Docking (o=Optional)

For some special applications, user might re-install OS and lose the COM port settings. To make sure the features works properly with Hottab Utility, please follow the procedure below to re-define the COM port numbers:

1. Go to "**Device Manager**", right click on the COM number need to be changed, and tap on "**Properties**" to open the setting page.

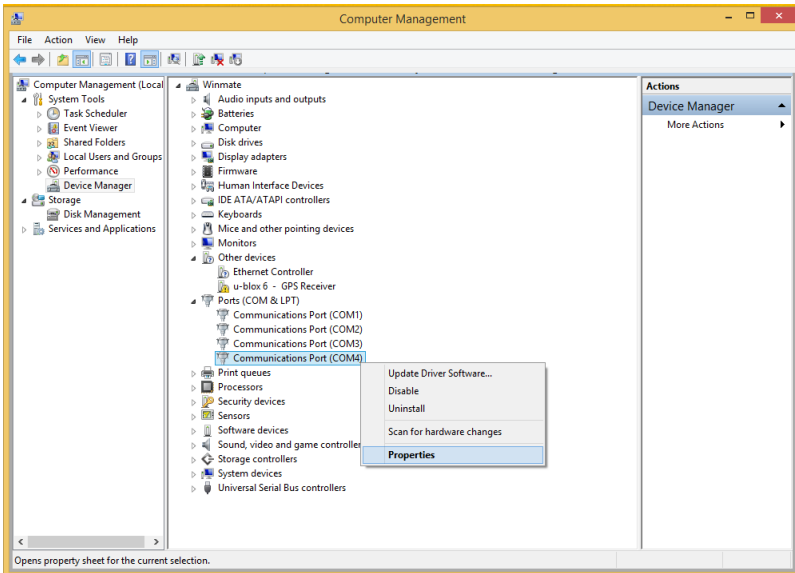

2. Tap on "**Port Setting**" tab and click on "**Advanced**" button.

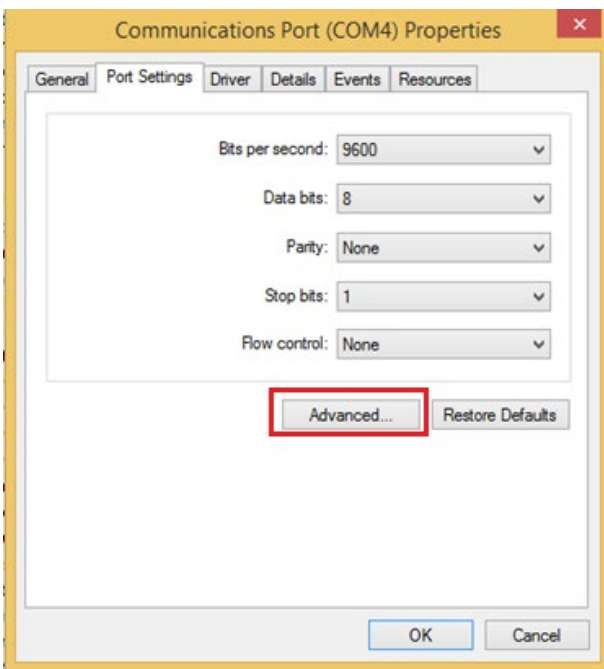

3. Tap on the dropdown list and choose the correct COM Port Number (refer to the COM Port Definition Table), and click "**OK**".

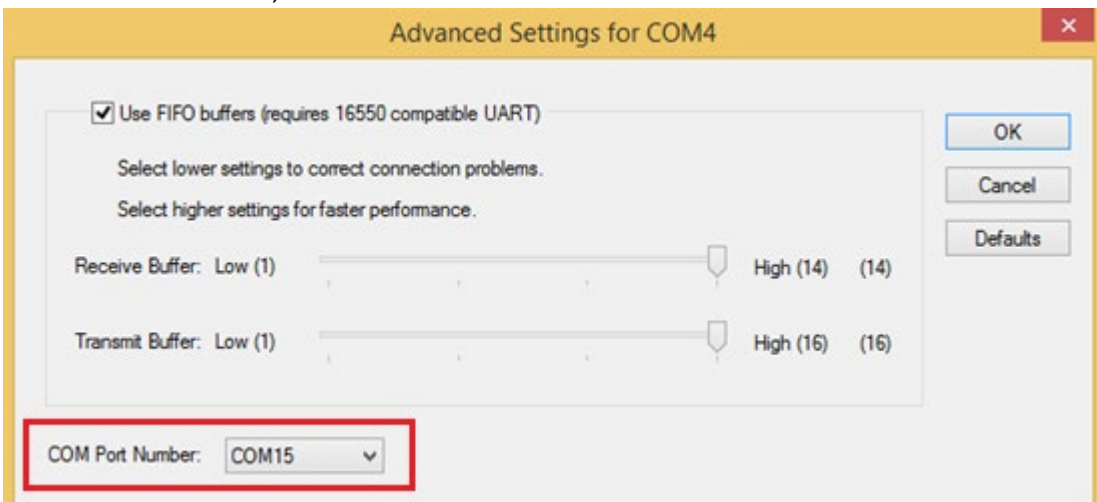

4. Double-check "**Device Manager**" to make sure the COM Port number has been re-defined successfully, and then restart the system.

## 5.6 GigaLAN Port Definition

Notice that GigaLAN port is an optional feature of the M116K Rugged Tablet and may not be present in your device. Please check your order specifications for more details.

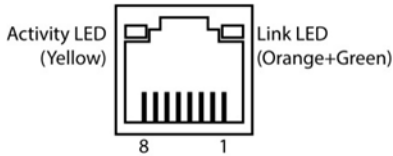

Pin №	Signal Name	Pin №	Signal Name
1	TX1+	2	TX1-
3	TX2+	4	TX3+
5	TX3-	6	TX2-
7	TX4+	8	TX4-

## 5.7 Pairing with a Wireless Bluetooth Barcode Scanner

The computer is affixed with a Bluetooth MAC (Media Access Control) address barcode label that enables wireless Bluetooth Barcode Scanner to quickly establish Bluetooth connection with the computer. It is encoded with leading characters to instruct the wireless Bluetooth barcode scanner to initial Bluetooth Serial Port Profile pairing request.

### 5.7.1 Setup Computer for Bluetooth Pairing

To start the pairing process, first perform the following steps to ensure the computer is properly setup for pairing:

1. Locate the **Bluetooth** icon in the Notification Area

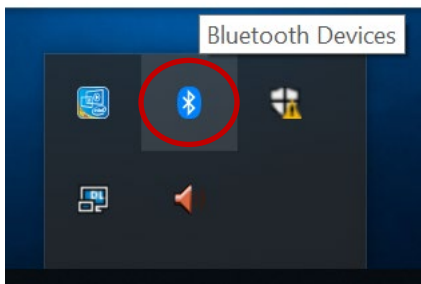

2. Bring up the Contextual Menu by performing long press on the icon with touchscreen or right-click on the icon with a mouse, and select **Open Settings**.

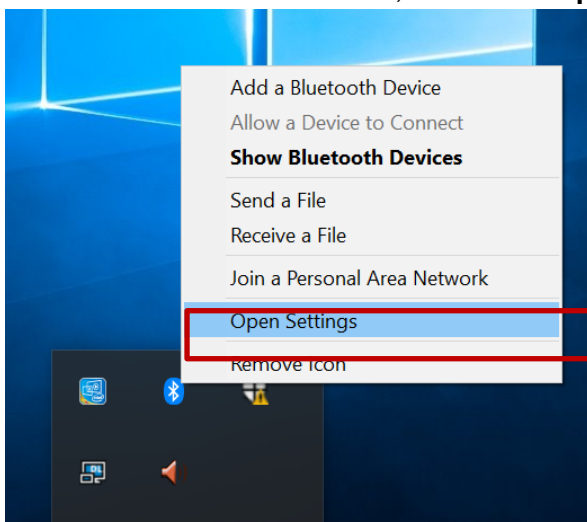

- Once the **Bluetooth & other devices** Menu appears, click **“More Bluetooth options”** under Related settings section as shown below.

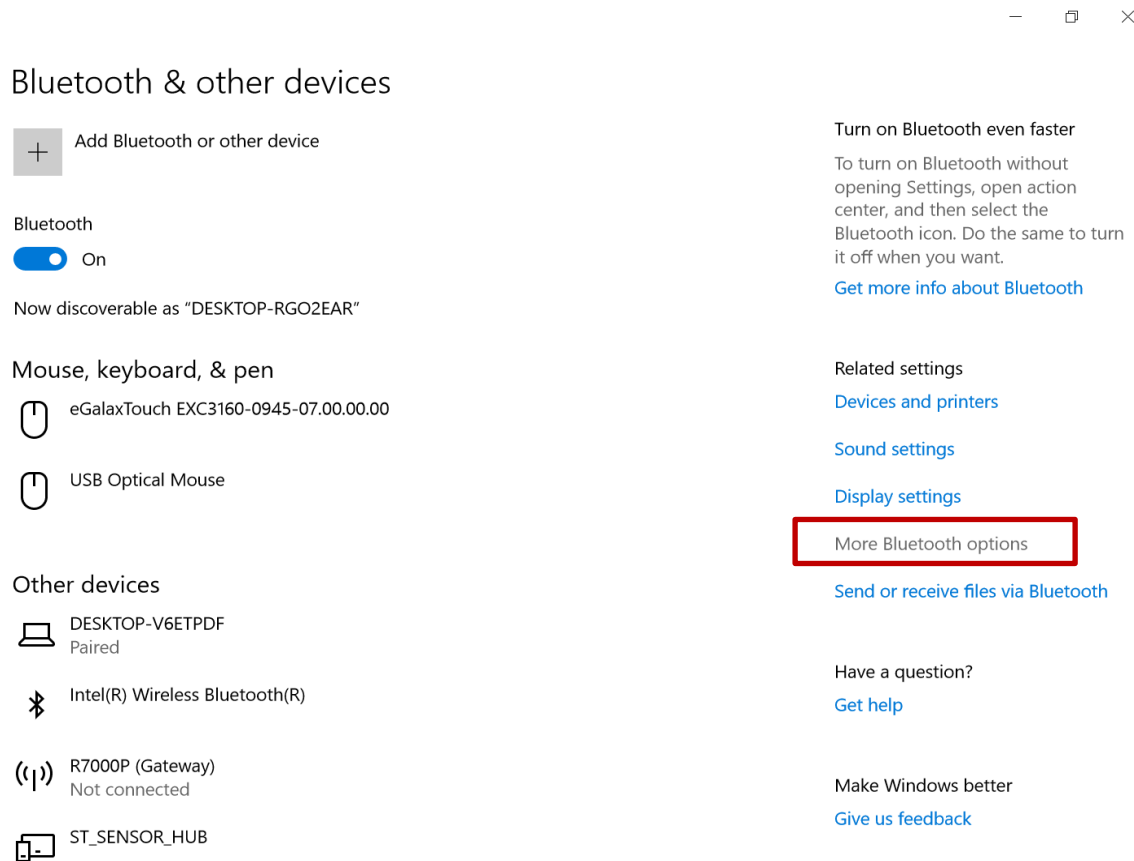

- go to **“Options”** tab, and make sure that in the Discovery section, the computer is set to **“Allow Bluetooth devices to find this computer”**, as shown below:

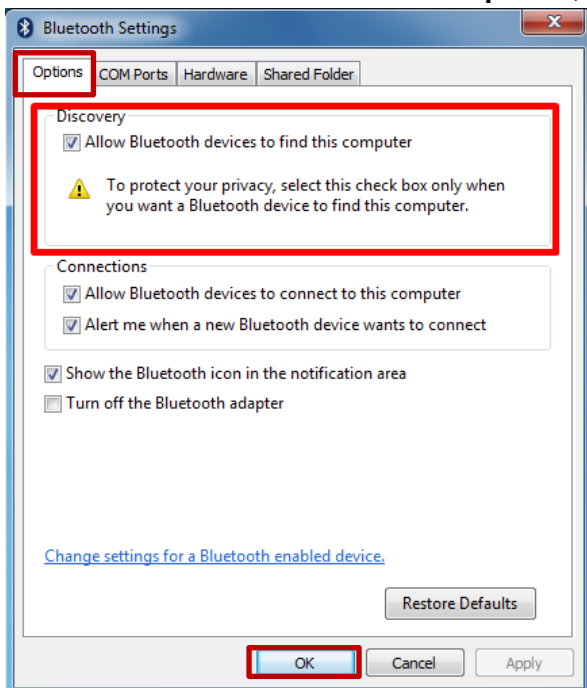

Click **OK** to continue.

- In the **Bluetooth Settings** menu, go to **“COM Ports”** tab. COM port has to be setup for the wireless Bluetooth Barcode Scanner to communicate via the Bluetooth Serial Port Profile. Click on the **“Add...”** button.



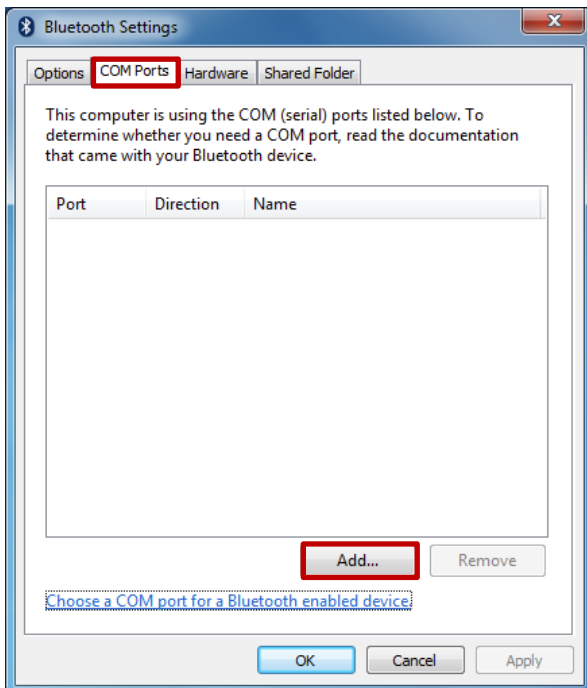

6. You are in “Add COM Port” window. Choose “Incoming (device initiates the connection)”, and click “OK”.

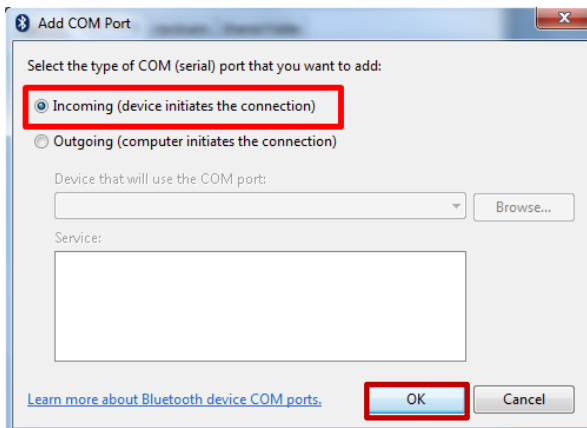

7. The computer will automatically assign COM Port to the Bluetooth connection. In the screenshot below, **COM4** is allocated.

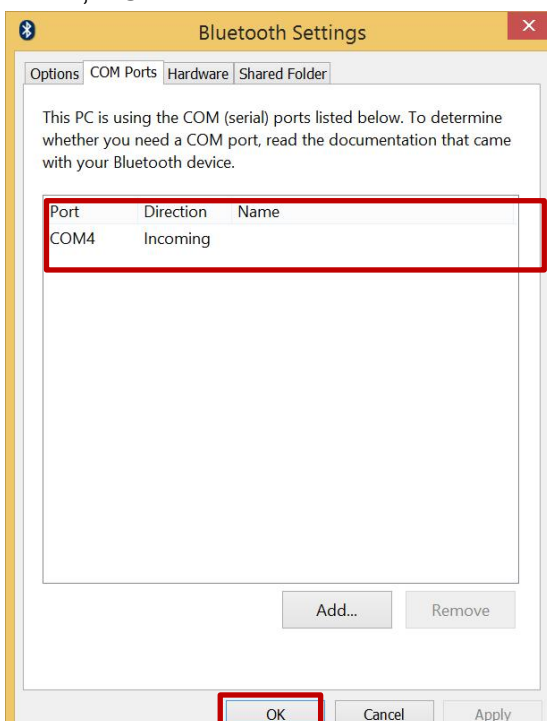

Click **OK** to continue.

- Next, the user has to configure the application that is used to accept the scanned data from the wireless Bluetooth Barcode Scanner. The application has to be configured to accept the same COM Port that has been assigned for the Bluetooth Serial Port Profile in the previous step.



**Important:** Make sure the application stays open while pairing.

- Now the computer is ready for pairing process to start

### 5.7.2 Set up the Barcode Scanner for Bluetooth Pairing



**Important** The wireless Bluetooth Barcode Scanner has to be configured as Bluetooth Serial Port Profile Master device to establish a connection via Bluetooth MAC address barcode label. For more detailed instruction, please refer to the User Guide for the wireless Bluetooth Barcode Scanner you are using for pairing.

Now the Barcode Scanner is ready for the pairing process to start.

### 5.7.3 Perform Bluetooth Pairing

After you finish setting up both the Computer and Barcode Scanner you are ready to start pairing.

- Open a program that is used for pairing.
- Perform scanning procedures. A Bluetooth notification window pop-up on the right-hand side of the desktop. **Left click** on the mouse to enter Add a device menu.
- Locate the **Bluetooth** icon  in the Notification Area.

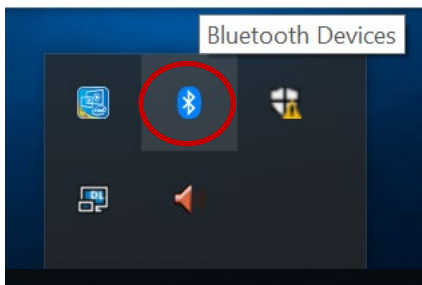

- Click **Add Bluetooth Device**.

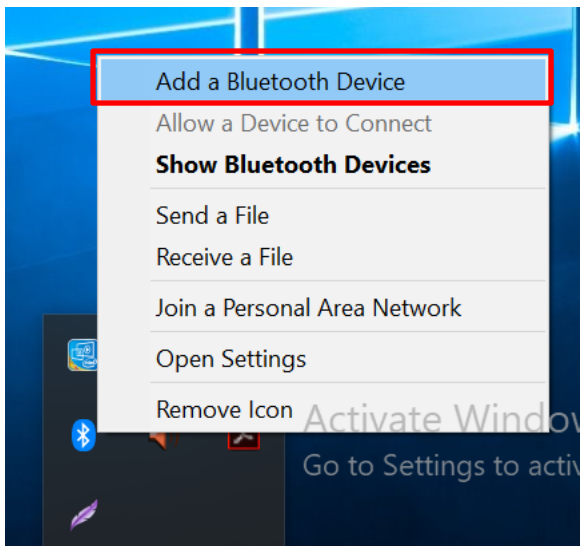

5. In **Add a Bluetooth Device** window, click **Next** to connect the Barcode Scanner to the computer.

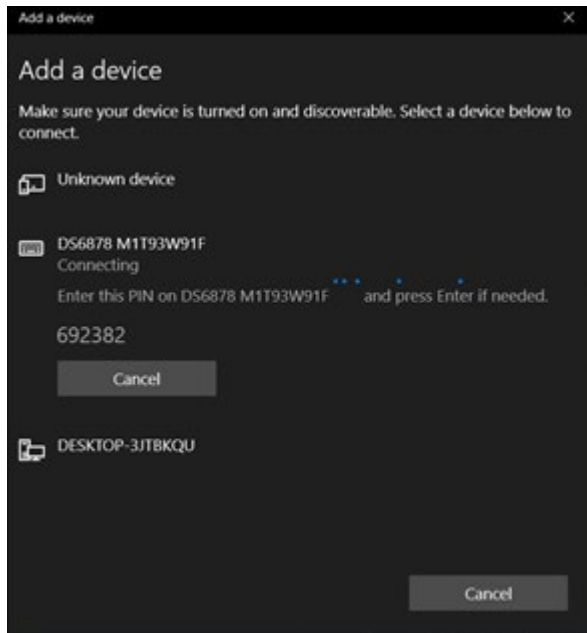

In order to ensure that Bluetooth Device is successfully paired to the computer, follow the steps below:

1. Locate the **Bluetooth** icon in the Notification Area. Select **Show Bluetooth Devices**.

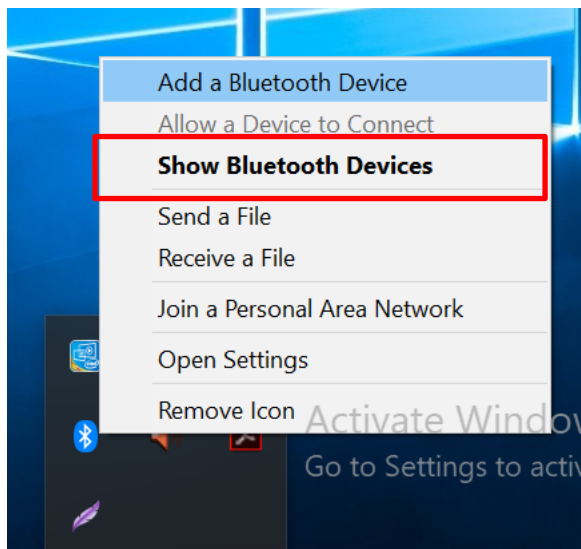

You can access this menu in the Control Panel:

Windows  → Control Panel → Devices and Printers → Bluetooth Devices

2. Make sure your device is connected to the computer.

## Chapter 6: Troubleshooting

### 6.1 Basic Troubleshooting

Problem	Solution
<b>The removable battery is not charging.</b>	<ul style="list-style-type: none"> <li>• Make sure the AC adapter is properly connected, and that the removable battery is properly inserted.</li> </ul>
<b>Nothing appears on the screen.</b>	<ul style="list-style-type: none"> <li>• The Tablet Computer may be in sleep mode. Press the power button to wake up the display.</li> <li>• The brightness level may be too low. Increase brightness.</li> </ul>
<b>The screen suddenly turns blank and the power indicator goes off.</b>	<ul style="list-style-type: none"> <li>• Make sure that LED indicator is not powered off in Hottab.</li> <li>• Make sure the AC adapter is properly connected.</li> <li>• If running on battery power, the battery may be depleted, charge the battery.</li> </ul>
<b>Wireless LAN signal quality is poor.</b>	<ul style="list-style-type: none"> <li>• The Tablet Computer may be out of range. Move the Tablet Computer closer to the access point or another wireless LAN device associated with it.</li> <li>• Check if your surroundings have interferences, such as microwave ovens, cordless phones. Move the Tablet Computer away from objects causing interference.</li> </ul>
<b>I cannot connect to another wireless LAN device.</b>	<ul style="list-style-type: none"> <li>• Make sure that the wireless LAN feature is powered.</li> <li>• Make sure that the SSID setting is the same for every wireless LAN device in the network.</li> <li>• Restart the Tablet Computer.</li> <li>• Make sure the IP address or subnet mask setting is correct.</li> </ul>
<b>I cannot connect to another device with Bluetooth.</b>	<ul style="list-style-type: none"> <li>• Make sure that both devices have Bluetooth powered on (For the Tablet Computer, check Hottab to see if Bluetooth is powered on).</li> <li>• Make sure that the distance between the two devices is within 10 meters, and there are no walls or large obstructions between the devices.</li> <li>• Make sure both devices are powered on and configured to be discoverable.</li> <li>• Make sure that both devices are compatible.</li> </ul>
<b>The GPS application cannot find my location.</b>	<ul style="list-style-type: none"> <li>• Make sure that GPS is powered on in Hottab.</li> <li>• Make sure that GPS receiver and the location sensor are enabled in Control Panel.</li> <li>• The Tablet Computer may be out of coverage area. Move your Tablet Computer outdoors or closer to a window.</li> <li>• Check if your surroundings have interferences, such as microwave ovens, cordless phones. Move the Tablet Computer away from objects causing interference.</li> </ul>

Problem	Solution
<b>No sound is produced.</b>	<ul style="list-style-type: none"> <li>• Adjust the volume of the Tablet Computer by pressing on the volume rocker.</li> <li>• If using an external audio device, make sure that the cable is connected correctly.</li> </ul>
<b>I cannot project the Tablet Computer display to another monitor.</b>	<ul style="list-style-type: none"> <li>• Make sure the VGA driver is installed.</li> <li>• Make sure the output setting selected is correct.</li> </ul>
<b>Barcode scanner does not emit a laser beam and does not seem to work.</b>	<ul style="list-style-type: none"> <li>• Make sure the Barcode scanner device is enabled in Hottab utility.</li> <li>• Make sure under Windows; the Barcode Reader is set to COM 15 port, so that Hottab can trigger the Barcode Reader hardware.</li> </ul>
<b>Barcode Scanner emits a laser beam but does not read the barcode presented to it.</b>	<ul style="list-style-type: none"> <li>• Adjust the distance between the barcode scanner of the device and the barcode being scanned.</li> <li>• Make sure the barcode code type is enabled in the Tablet. To enable/disable a specific barcode code type, go through the "Barcode Scanner Configuration" section.</li> </ul>
<b>I am having GPS accuracy issue</b>	<ul style="list-style-type: none"> <li>• When utilizing the GPS function, we recommend disabling the Barcode Reader in Hottab to reduce interference.</li> </ul>
<b>RFID scanner does not seem to work.</b>	<ul style="list-style-type: none"> <li>• Make sure under Windows; the RFID hardware is set to COM 3 port.</li> </ul>
<b>Battery leaking or swollen</b>	<ul style="list-style-type: none"> <li>• The lithium battery used in this Tablet may swell after being charged/ discharged many times, but there is no problem regarding safety.</li> <li>• Continued use in such a state may result in the battery getting jammed, so please stop using the battery, and purchase a new one.</li> </ul>

## Appendix

### Appendix A: Product Specifications

Model Name	M116K	
Display Specification	Size	11.6-inch display with LED Backlight
	Resolution	1920 x 1080 Full HD
	Panel Brightness	850 nits with direct optical bonding for sunlight readability
	Contrast Ratio	1000:1
	Viewing Angle	89/89/89/89
	Touch	Projected capacitive multi-touch
	Technology	<ul style="list-style-type: none"> <li>• Anti-glare technology</li> <li>• Automatic screen rotation</li> </ul>
System Specification	Processor	Intel® Core™ i5-7300U 2.60 GHz
	System Memory	4 GB DDR4 SDRAM 1 (up to 16 GB)
	Graphics	Intel® HD Graphics 620
	Storage	128GB SSD (options up to 512GB) Additional storage available with micro SDXC card slot
	Operating System	Windows® 10 IoT Enterprise (64 bit)
	Sensors	Light sensor/ g-sensor / Gyro / E-compass
Wireless Communications	WLAN	802.11 a/b/g/n/ac WiFi
	Bluetooth	Bluetooth 5.0
	GNSS	GPS, GLONASS
	WWAN	Optional 4G LTE
Interfaces	Docking Connector	1 x 19-pin docking connector
	HDMI	1 x micro HDMI
	USB	1 x USB 3.0 (Type A), 1 x USB 3.0 (Type C) <b>Note:</b> The USB Type-C connector follows USB 3.0 standard, which does not support Alternate Mode (ALT) or USB Power Delivery (USB-PD).
	Power Input	1 x Power Jack
	Micro SD	1 x Micro SDXC slot
	Audio	1 x Audio combo connector (Mic in or Line Out)
	LAN	1 x RJ45-10/100/1000 GigaLAN port (Optional)
	Micro SIM	1 x Micro SIM card slot
	mini PCIe	1 x Mini PCIe for WWAN Module
Input	Buttons	1 x Power; 3 x function keys
	Touch	10-point multi-touch, supports Rain / Glove / Stylus Modes
Status Indicators	LED Indicators	Power, Battery, HDD, RF

Model Name		M116K
Audio	Microphone	Built-in dual digital mic with noise cancellation
	Speaker	2 x 1 watt front-facing speakers
Cameras	Web Camera	2MP front camera
	Rear Camera	8MP rear camera with autofocus and LED light
Data Capture	Integrated	Optional 1D/2D Barcode Reader Optional HF RFID Reader
Security Function	Security	<ul style="list-style-type: none"> <li>Trusted Platform Module (TPM) 2.0 <sup>2</sup></li> <li>Kensington Lock</li> </ul>
	Mobile Device Management	SOTI Mobicontrol compatible <sup>3</sup>
Power Management	Power Input	19V DC
	AC Adapter	100-240V, 50-60Hz (19V DC)
	Battery	Hot-swappable 7.7V typ. 5900 mAh Li-Polymer Battery (2S1P) Optional 7.4V typ. 10280 mAh Li-Polymer Battery (2S2P)
	Battery Operating Time	Std. Battery: 8 hours <sup>4</sup>
Mechanical	Dimensions	300.67 x 201.97 x 22.5 mm
	Weight	1.4 kg
Environment	Operating Temp.	-20°C ~ +60°C (AC Mode), -10°C ~ +50°C (Battery Mode)
	Humidity	10 to 90% RH, non-condensing
	IP Rating	IP65, dustproof and waterproof
	Shock	MIL-STD-810G Method 516.6 Procedure I
	Vibration	MIL-STD-810G Method 514.6 Procedure I
	Drop	MIL-STD-810G Method 516.6
Standards and Certification	EMC	CE, FCC

1. Total usable memory will be less depending upon actual system configuration.
2. TPM 2.0 available upon request.
3. SOTI is available upon request.
4. Measured at dimming LCD brightness. Varies depending on the usage conditions, or when an external device is attached.
5. Length measurements do not include protrusions. Weight varies with options.
6. This is a simplified drawing and some components are not marked in detail.

---

Winmate Inc.  
9F, No.111-6, Shing-De Rd., San-Chung District,  
New Taipei City 24158, Taiwan, R.O.C  
[www.winmate.com](http://www.winmate.com)

